

2022全國學童盃足球錦標賽-北區預賽
公開四年級組

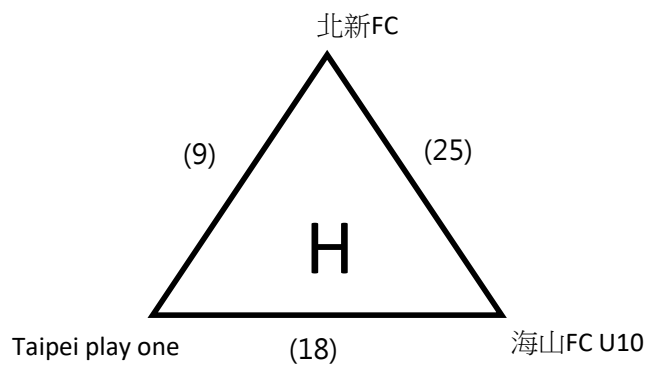

2022全國學童盃足球錦標賽-北區預賽
公開四年級組

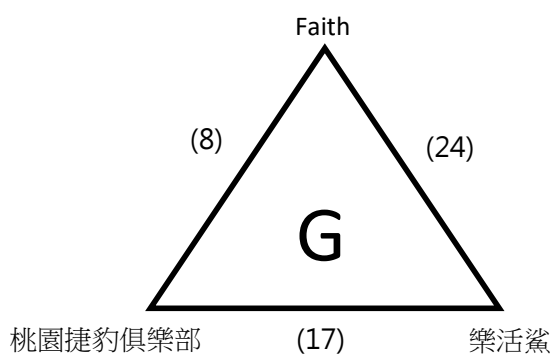
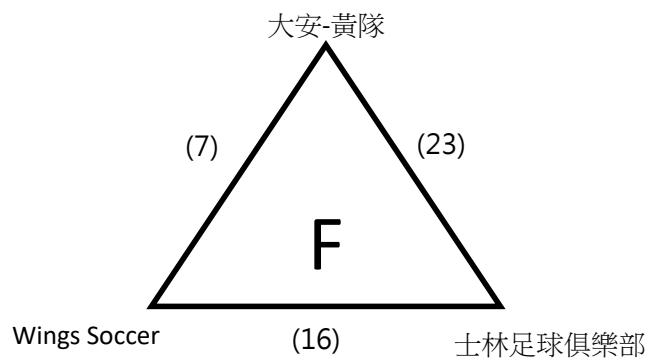
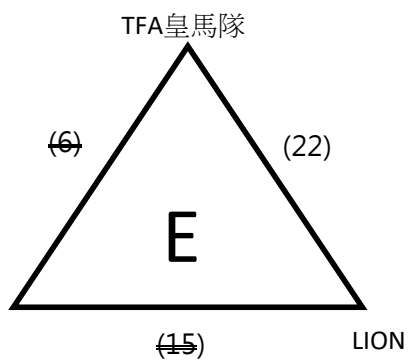
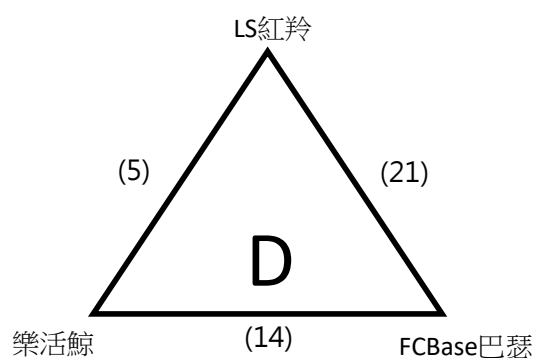
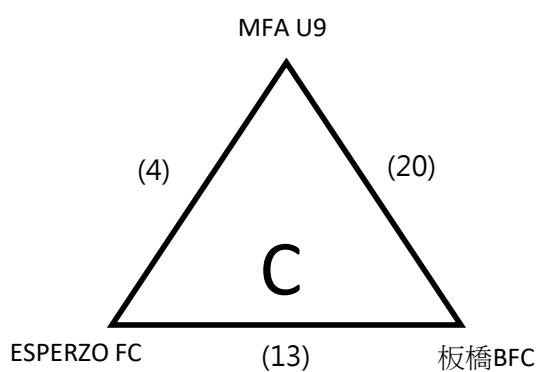
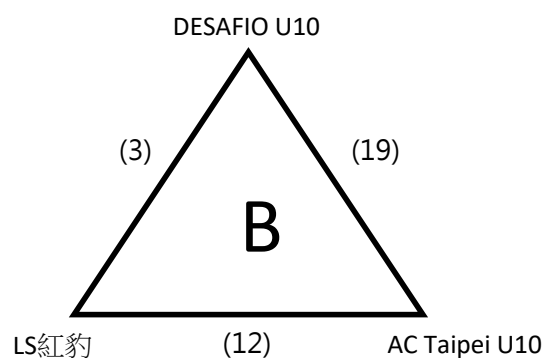
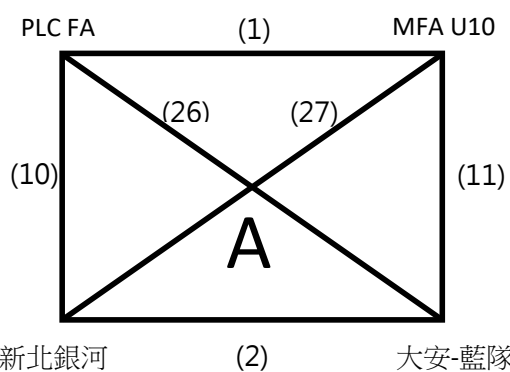
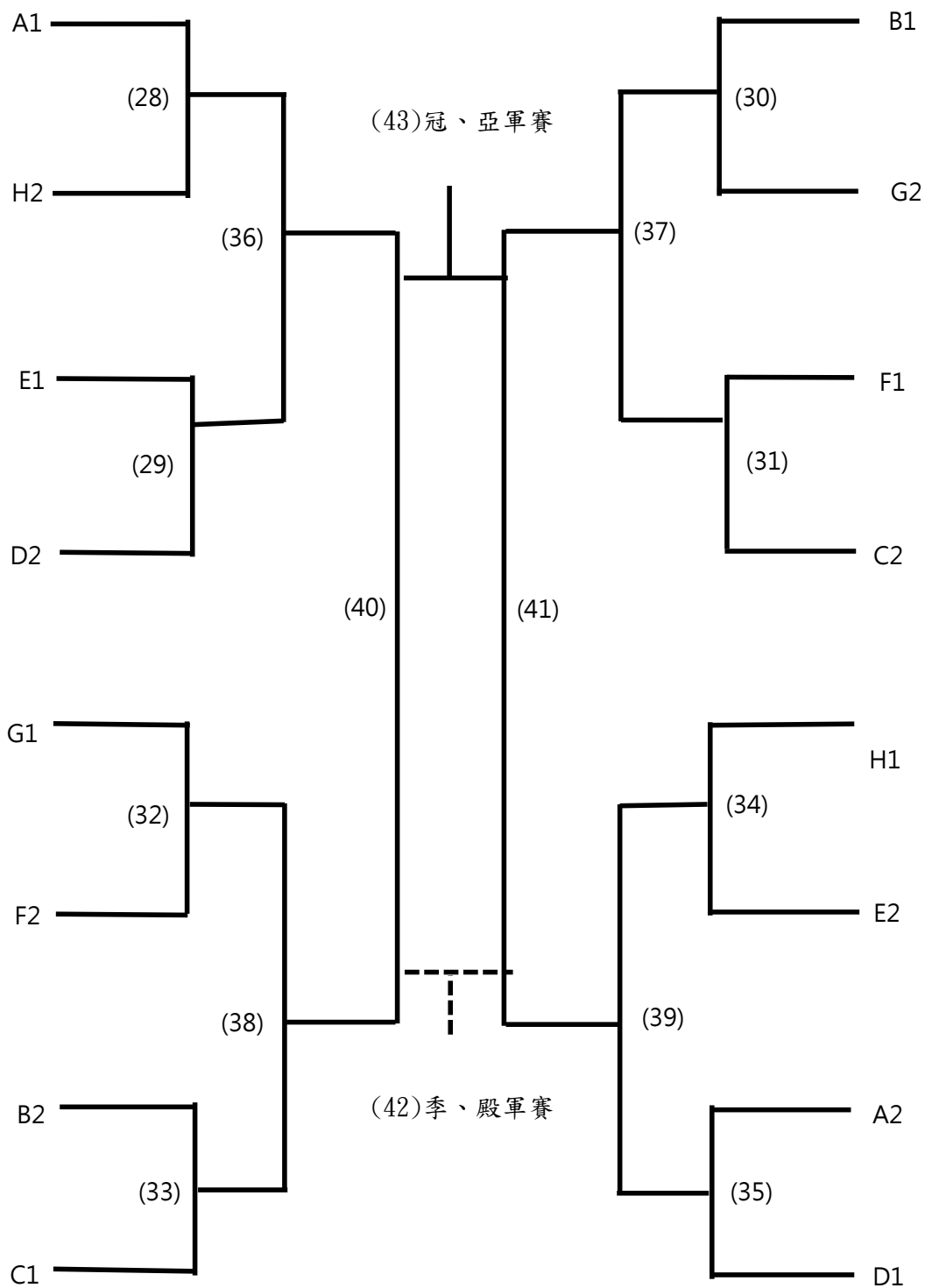

2022全國學童盃足球錦標賽-北區預賽

公開四年級組

日期	時間	場地	場次	隊名	成績	隊名	
9/17 (六)	08:30	A	(1)	PLC FA		MFA U10	
		B	(2)	新北銀河		大安足球俱樂部-藍隊	
		C	(3)	DESAFIO U10		LS紅豹	
	09:30	A	(4)	MFA U9		ESPERZO FC	
	10:30	A	(7)	大安足球俱樂部-黃隊		Wings Soccer	
		B	(8)	Faith		桃園捷豹俱樂部	
		C	(9)	北新FC		Taipei play one	
	12:30	C	(10)	新北銀河		PLC FA	
	13:30	A	(11)	大安足球俱樂部-藍隊		MFA U10	
		B	(12)	LS紅豹		AC Taipei U10	
		C	(13)	ESPERZO FC		板橋BFC	
	14:30	A	(14)	樂活鯨		FCBase巴瑟	
		B	(22)	LION		TFA皇馬隊	
		C	(16)	Wings Soccer		士林足球俱樂部	
	15:30	A	(17)	桃園捷豹俱樂部		樂活鯊	
		B	(18)	Taipei play one		海山FC U10	
	9/18 (日)	10:30	A	(19)	AC Taipei U10		DESAFIO U10
			B	(20)	板橋BFC		MFA U9
C			(21)	FCBase巴瑟		LS紅羚	
11:30		B	(23)	士林足球俱樂部		大安足球俱樂部-黃隊	
		C	(24)	樂活鯊		Faith	
12:30		B	(26)	大安足球俱樂部-藍隊		PLC FA	
		C	(27)	MFA U10		新北銀河	
13:30		A	(25)	海山FC U10		北新FC	
15:30		A	(5)	LS紅羚		樂活鯨	
9/24 (六)	08:30	A	(28)	A1		H2	
		B	(29)	E1		D2	
	09:30	A	(30)	B1		G2	
		B	(31)	F1		C2	
	10:30	A	(32)	G1		F2	
		B	(33)	B2		C1	
	11:30	A	(34)	H1		E2	
		B	(35)	A2		D1	
	12:30	C	(36)	(28)W		(29)W	
	13:30	C	(37)	(30)W		(31)W	
	14:30	A	(38)	(32)W		(33)W	
		B	(39)	(34)W		(35)W	
9/25 (日)	11:30	A	(40)	(36)W		(38)W	
		B	(41)	(37)W		(39)W	
	15:30	B	(42)	季、殿軍賽(40)L		季、殿軍賽(41)L	
		A	(43)	冠、亞軍賽(40)W		冠、亞軍賽(41)W	

2022全國學童盃足球錦標賽-北區預賽
公開五年級組

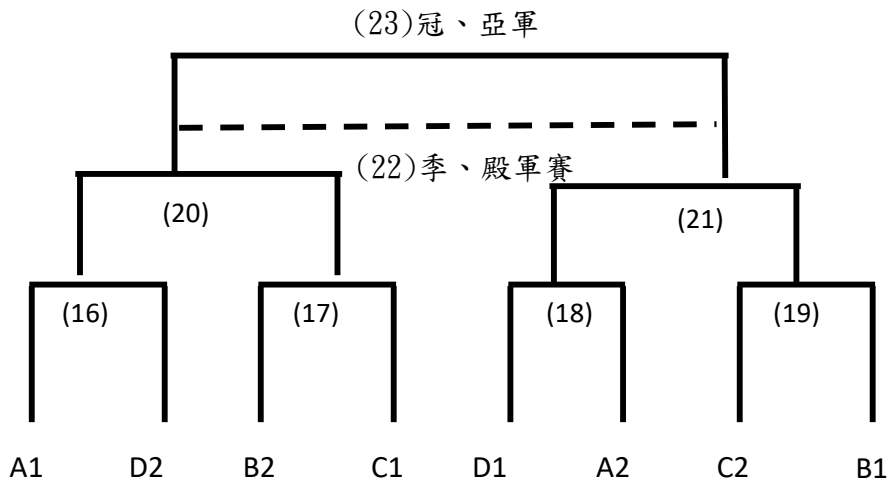
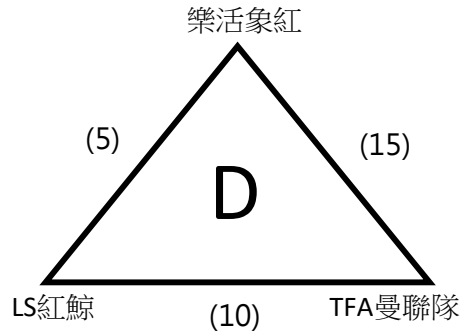
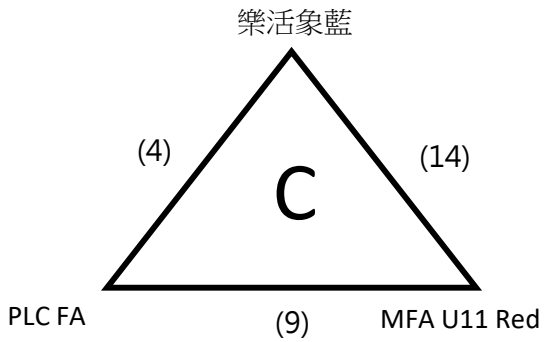
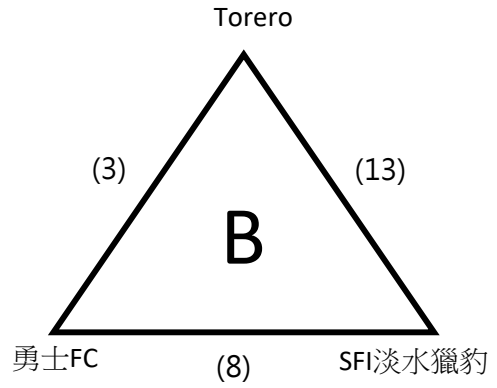
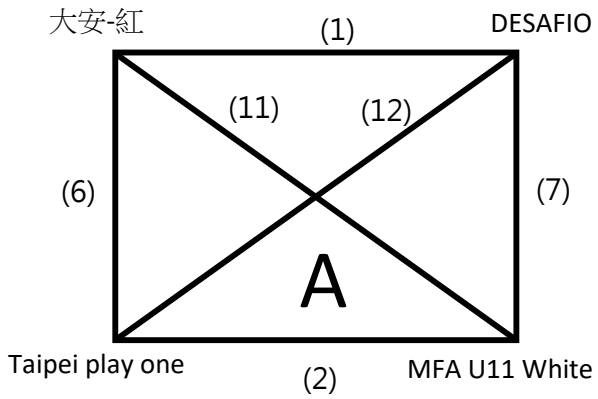

2022全國學童盃足球錦標賽-北區預賽
公開五年級組

日期	時間	場地	場次	隊名	成績	隊名
9/17 (六)	09:30	B	(15)	TFA曼聯隊		樂活象紅
	11:30	A	(5)	樂活象紅		LS紅鯨
		B	(1)	大安足球俱樂部-紅隊		DESAFIO U11
		C	(2)	Taipei play one		MFA U11 White
	12:30	A	(3)	Torero		永士FC
		B	(4)	樂活象藍		PLC FA
	15:30	C	(6)	Taipei play one		大安足球俱樂部-紅隊
	16:30	A	(7)	MFA U11 White		DESAFIO U11
		B	(8)	永士FC		SFI淡水獵豹
		C	(10)	LS紅鯨		TFA曼聯隊
9/18 (日)	12:30	A	(9)	PLC FA		MFA U11 Red
	13:30	B	(11)	大安足球俱樂部-紅隊		MFA U11 White
		C	(12)	DESAFIO U11		Taipei play one
	14:30	A	(13)	SFI淡水獵豹		Torero
15:30	B	(14)	MFA U11 Red		樂活象藍	
9/24 (六)	10:30	C	(16)	A1		D2
	11:30	C	(17)	B2		C1
	12:30	B	(18)	D1		A2
	13:30	B	(19)	C2		B1
	14:30	C	(20)	(16)W		(17)W
	15:30	C	(21)	(18)W		(19)W
9/25 (日)	12:30	B	(22)	季、殿軍賽(20)L		季、殿軍賽(21)L
		A	(23)	冠、亞軍賽(20)W		冠、亞軍賽(21)W

2022全國學童盃足球錦標賽-北區預賽
公開六年級組

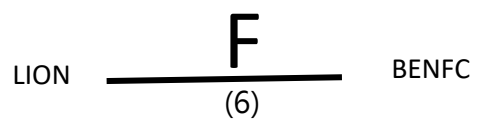
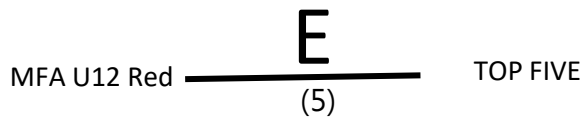
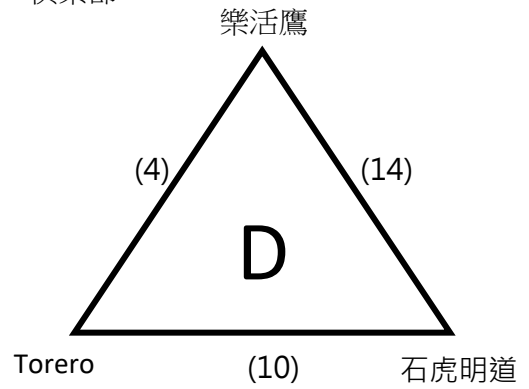
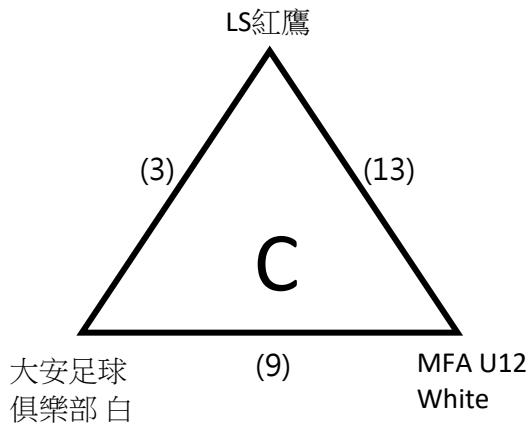
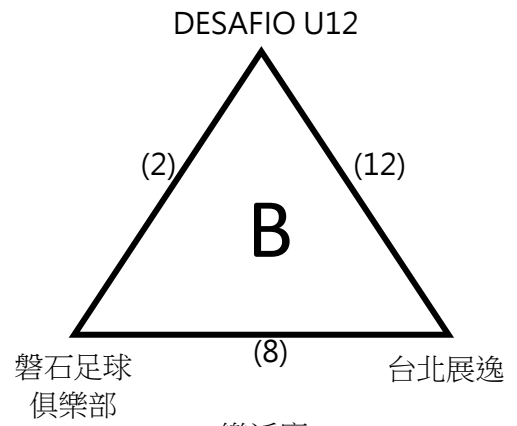
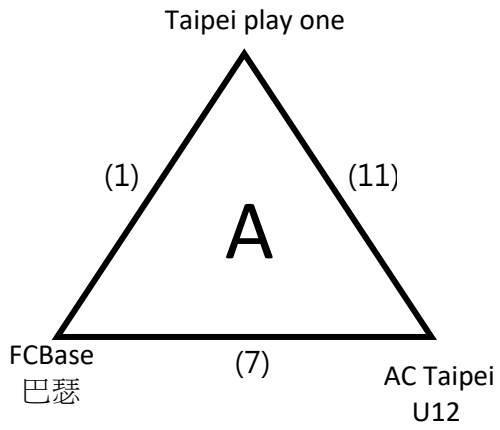

2022全國學童盃足球錦標賽-北區預賽
公開六年級組

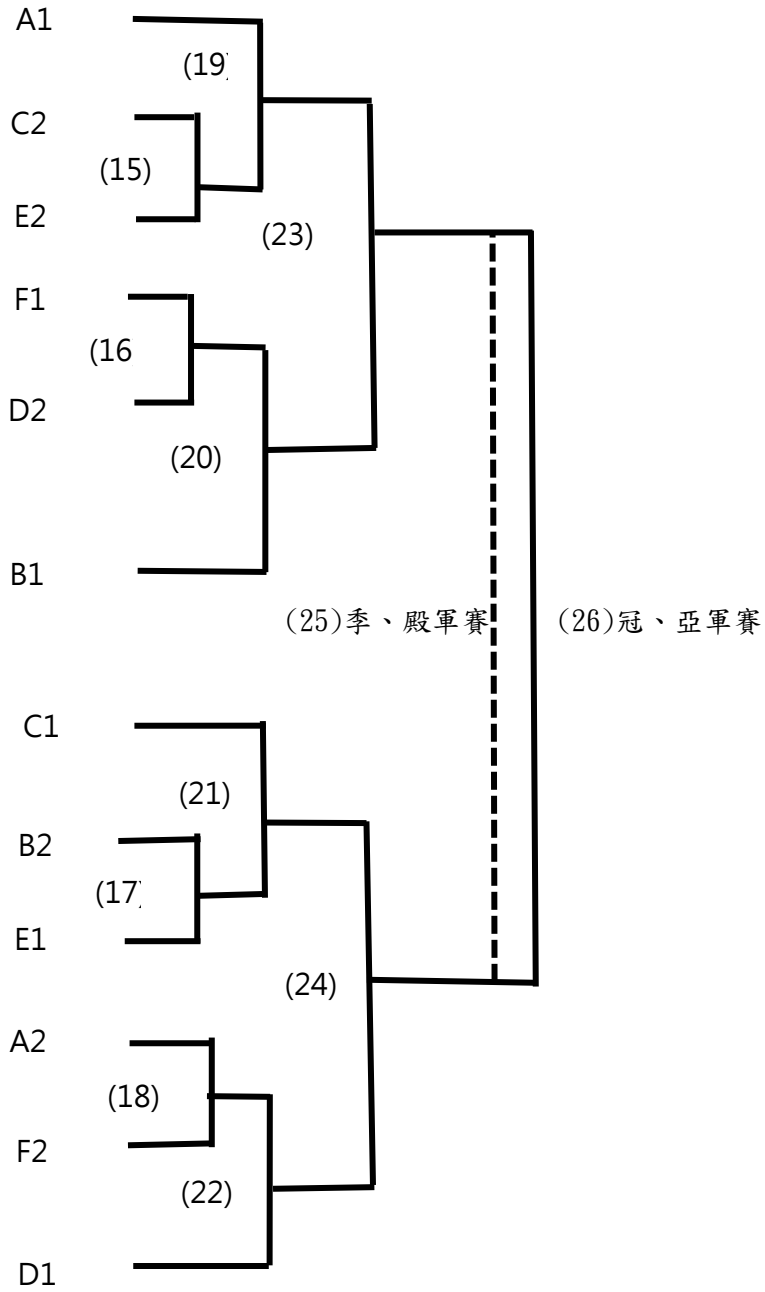

2022全國學童盃足球錦標賽-北區預賽
公開六年級組

日期	時間	場地	場次	隊名	成績	隊名
9/18 (日)	08:30	A	(1)	Taipei play one		FCBase巴瑟
		B	(2)	DESAFIO U12		磐石足球俱樂部
		C	(3)	LS紅鷹		大安足球俱樂部 白
	09:30	A	(4)	樂活鷹		Torero
		B	(5)	MFA U12 Red		TOP FIVE
		C	(6)	LION		BENFC
	14:30	B	(7)	FCBase巴瑟		AC Taipei U12
		C	(8)	磐石足球俱樂部		台北展逸天行者U12
9/24 (六)	08:30	C	(9)	大安足球俱樂部 白		MFA U12 White
	09:30	C	(10)	Torero		石虎明道
	12:30	A	(11)	AC Taipei U12		Taipei play one
	13:30	A	(12)	台北展逸天行者U12		DESAFIO U12
	15:30	A	(13)	MFA U12 White		LS紅鷹
		B	(14)	石虎明道		樂活鷹
9/25 (日)	09:30	A	(15)	C2		E2
		B	(16)	F1		D2
	10:30	A	(17)	B2		E1
		B	(18)	A2		F2
	13:30	A	(19)	A1		(15)W
		B	(20)	(16)W		B1
	14:30	A	(21)	C1		(17)W
		B	(22)	(18)W		D1
10/2 (日)	09:00	(待確認)	(23)	(19)W		(20)W
	10:00	(待確認)	(24)	(21)W		(22)W
	13:00	(待確認)	(25)	季、殿軍賽(23)L		季、殿軍賽(24)L
	14:00	(待確認)	(26)	冠、亞軍賽(23)W		冠、亞軍賽(24)W