

2022全國少年盃足球錦標賽 學校六年級組

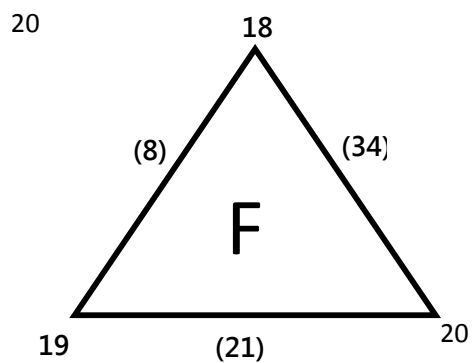

2022全國少年盃足球錦標賽 學校六年級組

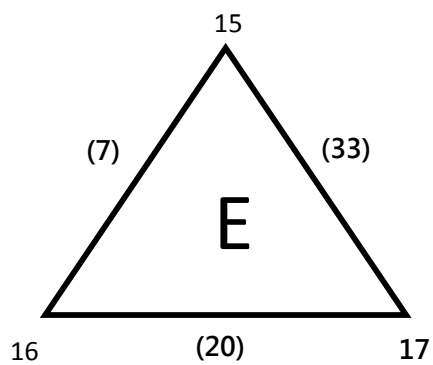
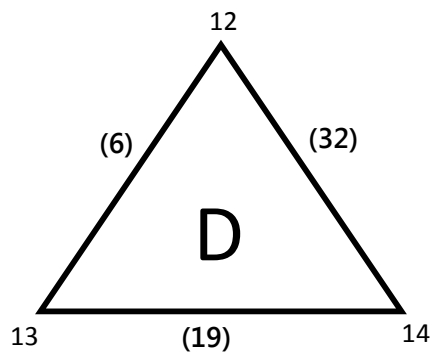
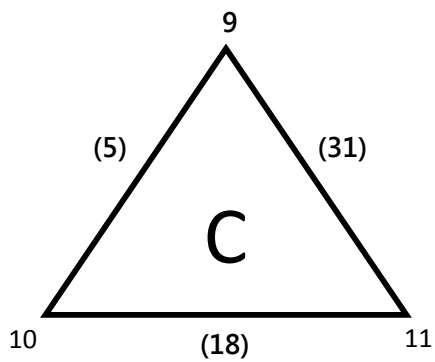
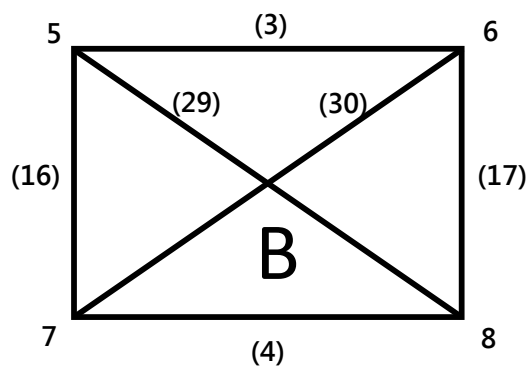
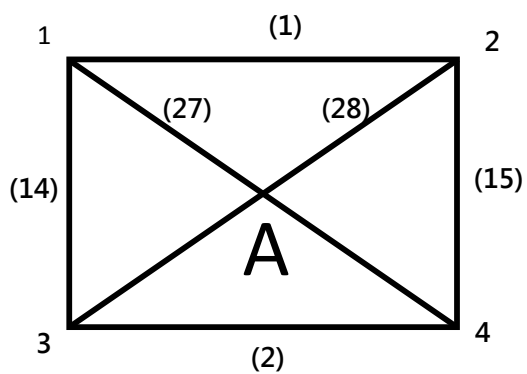
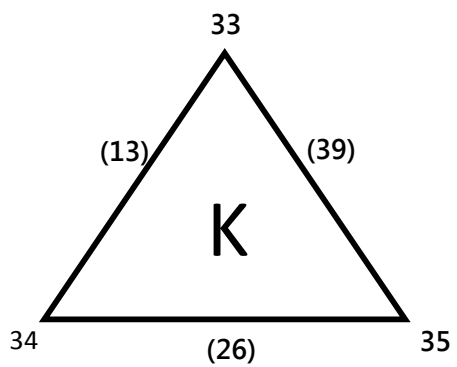
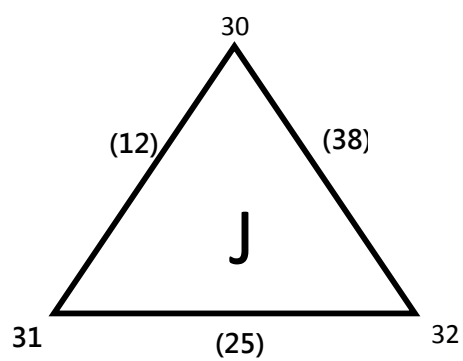
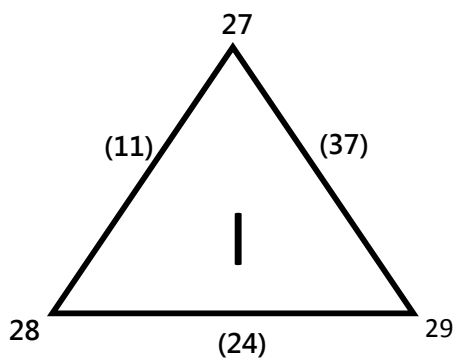
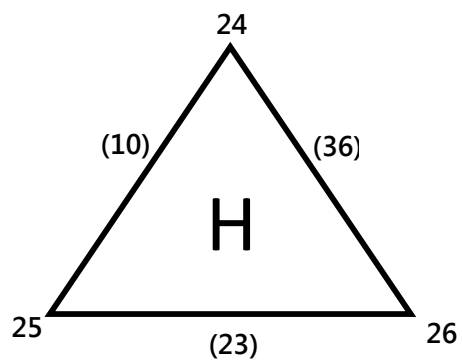
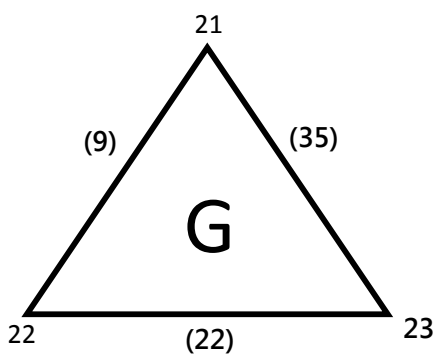

2022全國少年盃足球錦標賽 學校六年級組

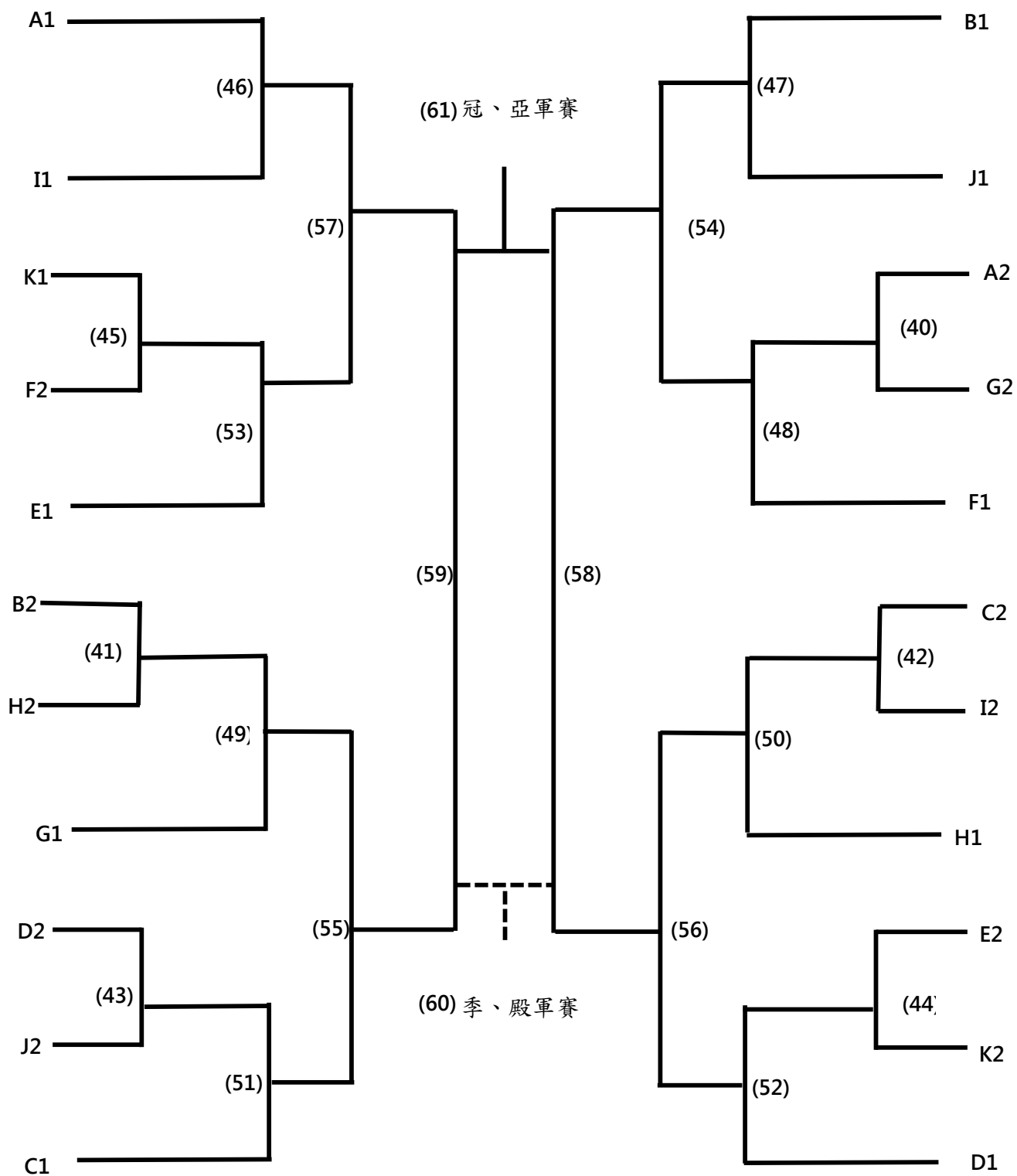

2022全國少年盃足球錦標賽 學校六年級組

日期	時間	場地	場次	隊名	成績	隊名
3月28日	08:00-08:50	百齡A1	(1)	1		2
	08:00-08:50	百齡A2	(2)	3		4
	08:55-09:45	百齡A1	(3)	5		6
	08:55-09:45	百齡A2	(4)	7		9
	09:50-10:40	百齡A1	(5)	9		10
	09:50-10:40	百齡A2	(6)	12		13
	10:45-11:35	百齡A1	(7)	15		16
	10:45-11:35	百齡A2	(8)	18		19
	11:40-12:30	百齡A1	(9)	21		22
	11:40-12:30	百齡A2	(10)	24		25
	12:35-13:25	百齡A1	(11)	27		29
	12:35-13:25	百齡A2	(12)	30		31
	13:30-14:20	百齡A1	(13)	33		34
3月29日	08:00-08:50	百齡A1	(14)	3		1
	08:00-08:50	百齡A2	(15)	4		2
	08:55-09:45	百齡A1	(16)	7		5
	08:55-09:45	百齡A2	(17)	8		6
	09:50-10:40	百齡A1	(18)	10		11
	09:50-10:40	百齡A2	(19)	13		14
	10:45-11:35	百齡A1	(20)	16		17
	10:45-11:35	百齡A2	(21)	19		20
	11:40-12:30	百齡A1	(22)	22		23
	11:40-12:30	百齡A2	(23)	25		26
	12:35-13:25	百齡A1	(24)	28		29
	12:35-13:25	百齡A2	(25)	31		32
13:30-14:20	百齡A1	(26)	34		35	
3月30日	08:00-08:50	百齡A1	(27)	1		4
	08:00-08:50	百齡A2	(28)	2		3
	08:55-09:45	百齡A1	(29)	5		8
	08:55-09:45	百齡A2	(30)	6		7
	09:50-10:40	百齡A1	(31)	11		9
	09:50-10:40	百齡A2	(32)	14		12
	10:45-11:35	百齡A1	(33)	17		15
	10:45-11:35	百齡A2	(34)	20		18
	11:40-12:30	百齡A1	(35)	23		21
	11:40-12:30	百齡A2	(36)	26		24
	12:35-13:25	百齡A1	(37)	29		27
	12:35-13:25	百齡A2	(38)	32		30
13:30-14:20	百齡A1	(39)	35		33	

2022全國少年盃足球錦標賽 學校六年級組

日期	時間	場地	場次	隊名	成績	隊名
3月31日	12:35-13:25	百齡A2	(40)	A2		G2
	13:30-14:20	百齡A1	(41)	B2		H2
	13:30-14:20	百齡A2	(42)	C2		I2
	14:25-15:15	百齡A1	(43)	D2		J2
	14:25-15:15	百齡A2	(44)	E2		K2
	15:20-16:10	百齡A1	(45)	K1		F2
4月1日	08:55-09:45	百齡A1	(46)	A1		I1
	08:55-09:45	百齡A2	(47)	B1		J1
	09:50-10:40	百齡A1	(48)	(40)W		F1
	09:50-10:40	百齡A2	(49)	(41)W		G1
	10:45-11:35	百齡A1	(50)	(42)W		H1
	10:45-11:35	百齡A2	(51)	(43)W		C1
	11:40-12:30	百齡A1	(52)	(44)W		D1
	11:40-12:30	百齡A2	(53)	(45)W		E1
	15:20-16:10	百齡A1	(54)	(47)W		(48)W
	15:20-16:10	百齡A2	(55)	(49)W		(51)W
	16:15-17:05	百齡A1	(56)	(50)W		(52)W
	16:15-17:05	百齡A2	(57)	(46)W		(53)W
4月2日	15:20-16:10	迎風C1	(58)	(54)W		(56)W
	15:20-16:10	迎風C2	(59)	(57)W		(55)W
4月3日	15:20-16:10	迎風C1	(60)	季、殿軍賽(58)L		季、殿軍賽(59)L
	15:20-16:10	迎風C2	(61)	冠、亞軍賽(58)W		冠、亞軍賽(59)W

2022全國少年盃足球錦標賽 學校五年級組

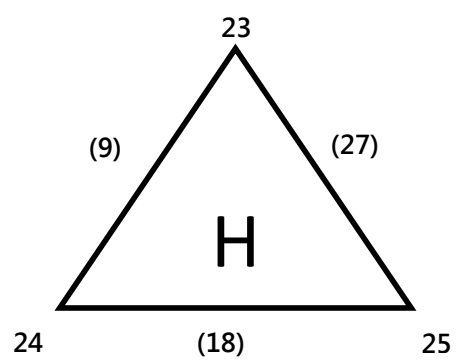
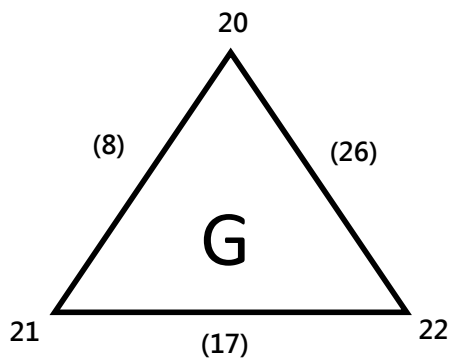
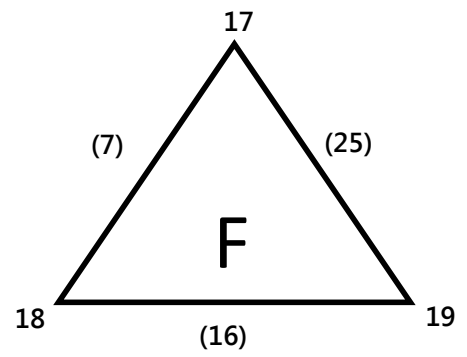
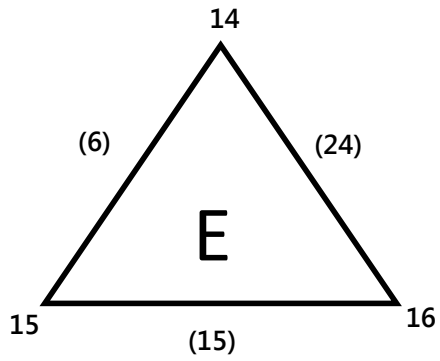
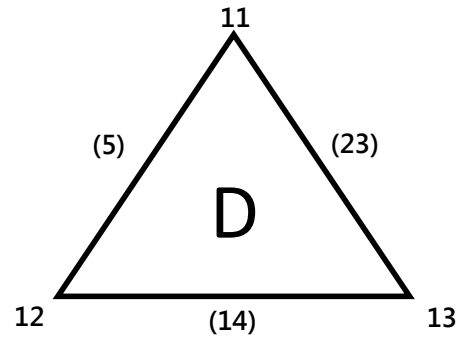
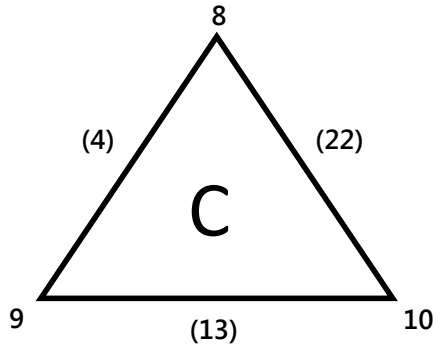
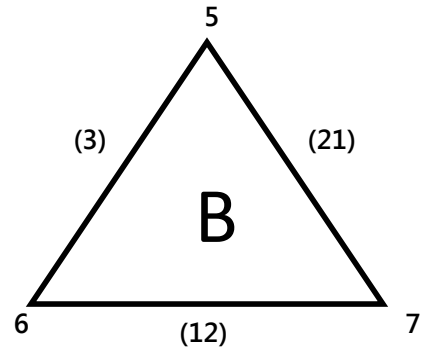
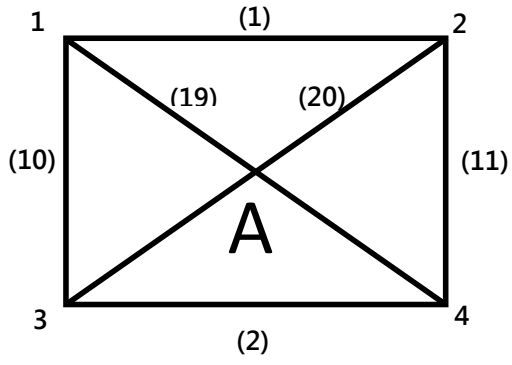

2022全國少年盃足球錦標賽 學校五年級組

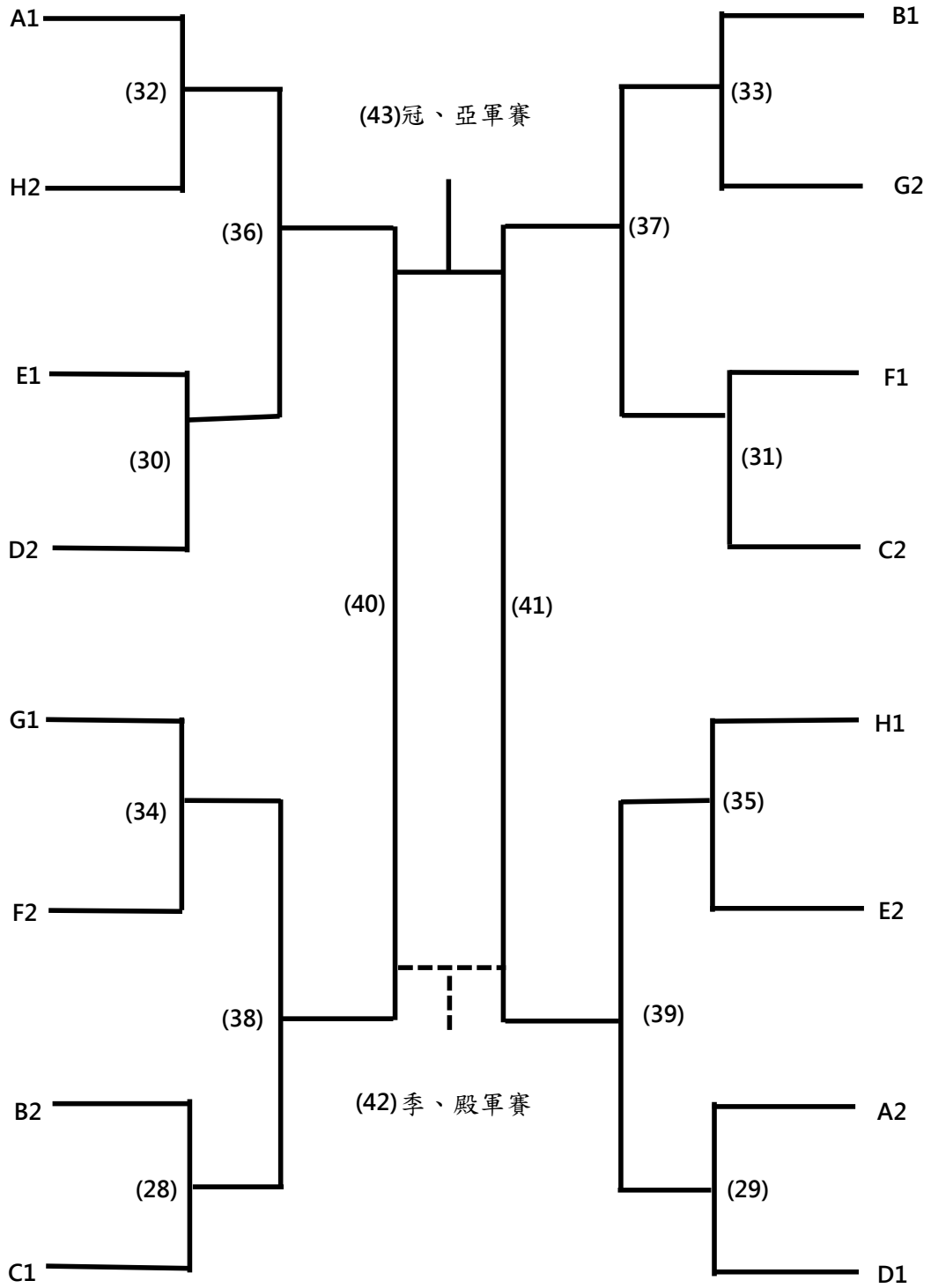

2022全國少年盃足球錦標賽 學校五年級組

日期	時間	場地	場次	隊名	成績	隊名
3月28日	13:30-14:20	百齡A2	(3)	5		6
	14:25-15:15	百齡A1	(1)	1		2
	14:25-15:15	百齡A2	(2)	3		4
	15:20-16:10	百齡A1	(4)	8		9
	15:20-16:10	百齡A2	(5)	11		12
	16:15-17:05	百齡A1	(6)	14		15
	16:15-17:05	百齡A2	(7)	17		18
	17:10-18:00	百齡A1	(8)	20		21
	17:10-18:00	百齡A2	(9)	23		24
3月29日	13:30-14:20	百齡A1	(12)	6		7
	14:25-15:15	百齡A2	(10)	3		1
	14:25-15:15	百齡A1	(11)	4		2
	15:20-16:10	百齡A2	(13)	9		10
	15:20-16:10	百齡A1	(14)	12		13
	16:15-17:05	百齡A2	(15)	15		16
	16:15-17:05	百齡A1	(16)	18		19
	17:10-18:00	百齡A2	(17)	21		22
	17:10-18:00	百齡A1	(18)	24		25
3月30日	13:30-14:20	百齡A2	(21)	7		5
	14:25-15:15	百齡A1	(19)	1		4
	14:25-15:15	百齡A2	(20)	2		3
	15:20-16:10	百齡A1	(22)	10		8
	15:20-16:10	百齡A2	(23)	13		11
	16:15-17:05	百齡A1	(24)	16		14
	16:15-17:05	百齡A2	(25)	19		17
	17:10-18:00	百齡A1	(26)	22		20
	17:10-18:00	百齡A2	(27)	25		23
3月31日	10:45-11:35	百齡B1	(28)	B2		C1
	10:45-11:35	百齡B2	(29)	A2		D1
	11:40-12:30	百齡B1	(30)	E1		D2
	11:40-12:30	百齡B2	(31)	F1		C2
	12:35-13:25	百齡B1	(32)	A1		H2
	12:35-13:25	百齡B2	(33)	B1		G2
	13:30-14:20	百齡B1	(34)	G1		F2
	13:30-14:20	百齡B2	(35)	H1		E2
4月1日	10:45-11:35	百齡B1	(36)	(32)W		(30)W
	10:45-11:35	百齡B2	(37)	(33)W		(31)W
	11:40-12:30	百齡B1	(38)	(34)W		(28)W
	11:40-12:30	百齡B2	(39)	(35)W		(29)W
4月2日	13:30-14:20	迎風C1	(40)	(36)W		(38)W
	13:30-14:20	迎風C2	(41)	(37)W		(39)W
4月3日	13:30-14:20	迎風C1	(42)	季、殿軍賽(40)L		季、殿軍賽(41)L
	13:30-14:20	迎風C2	(43)	冠、亞軍賽(40)W		冠、亞軍賽(41)W



2022全國少年盃足球錦標賽 學校四年級組

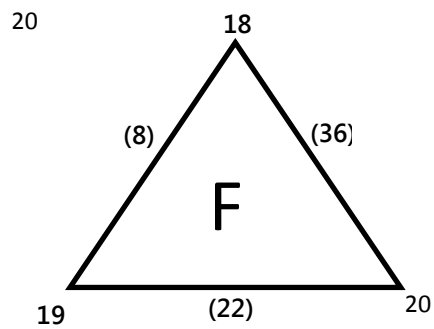
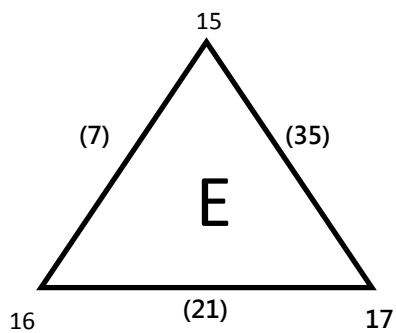
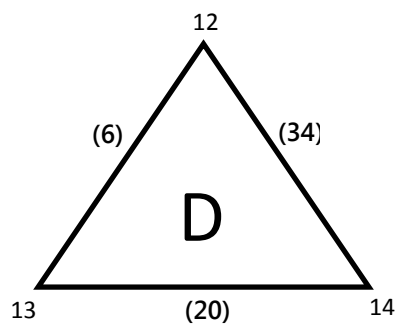
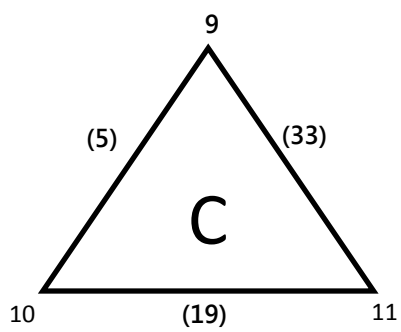
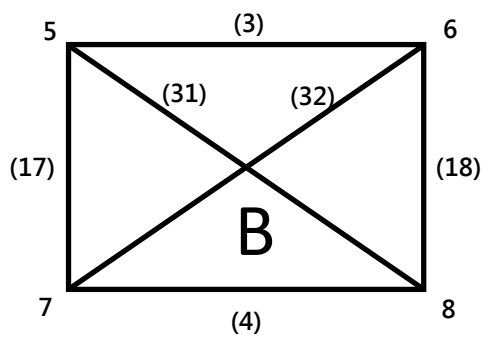
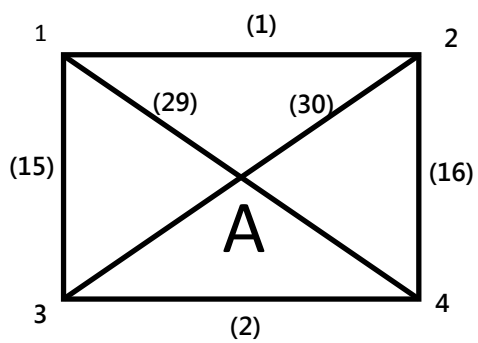

2022全國少年盃足球錦標賽 學校四年級組

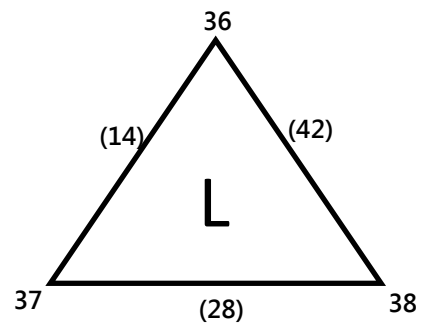
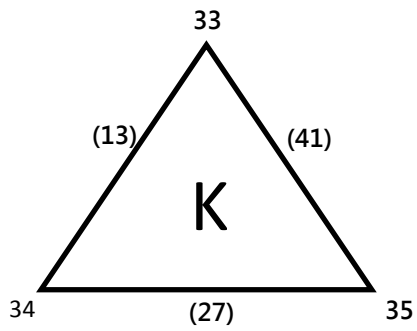
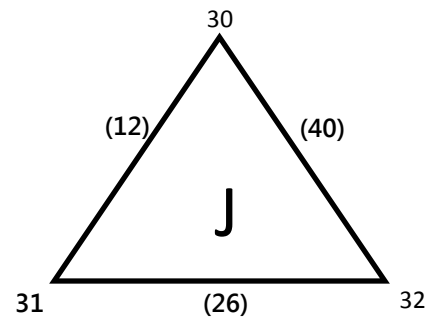
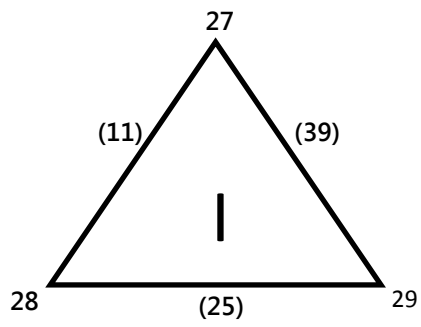
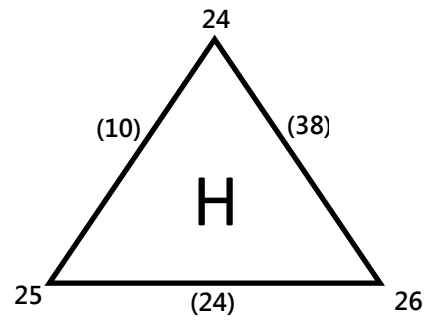
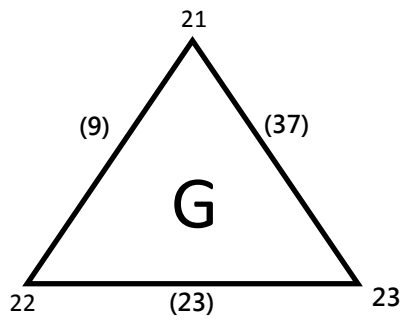

2022全國少年盃足球錦標賽 學校四年級組

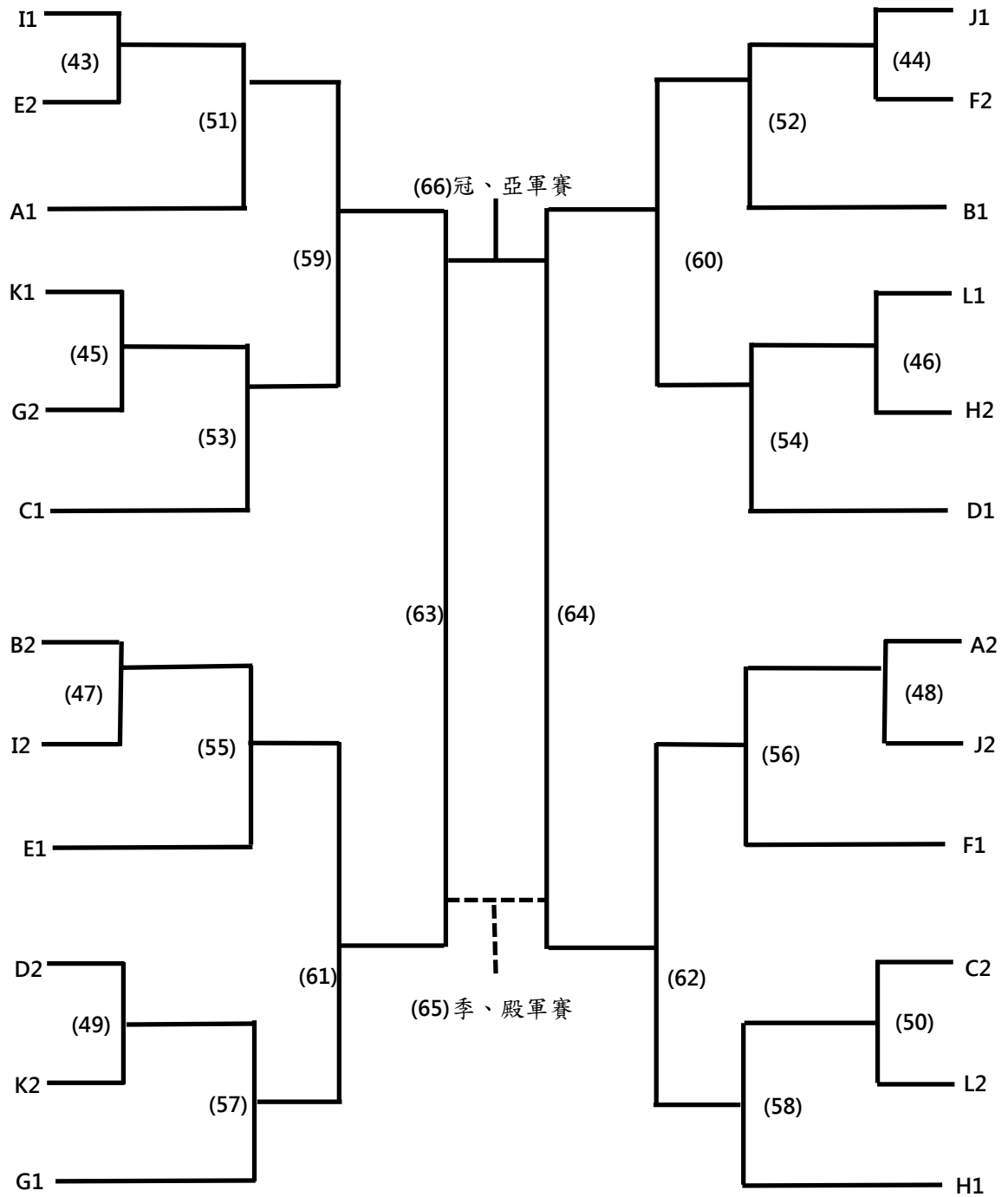

## 2022全國少年盃足球錦標賽 學校四年級組

日期	時間	場地	場次	隊名	成績	隊名
3月28日	08:00-08:50	百齡B1	(1)	1		2
	08:00-08:50	百齡B2	(2)	3		4
	08:55-09:45	百齡B1	(3)	5		6
	08:55-09:45	百齡B2	(4)	7		8
	09:50-10:40	百齡B1	(5)	9		10
	09:50-10:40	百齡B2	(6)	12		13
	10:45-11:35	百齡B1	(7)	15		16
	10:45-11:35	百齡B2	(8)	18		19
	11:40-12:30	百齡B1	(9)	21		22
	11:40-12:30	百齡B2	(10)	24		25
	12:35-13:25	百齡B1	(11)	27		28
	12:35-13:25	百齡B2	(12)	30		31
	13:30-14:20	百齡B1	(13)	33		34
	13:30-14:20	百齡B2	(14)	36		37
	14:25-15:15	百齡B1	(15)	3		1
	14:25-15:15	百齡B2	(16)	4		2
	15:20-16:10	百齡B1	(17)	7		5
	15:20-16:10	百齡B2	(18)	8		6
	16:15-17:05	百齡B1	(19)	10		11
	16:15-17:05	百齡B2	(20)	13		14
3月29日	08:00-08:50	百齡B1	(21)	16		17
	08:00-08:50	百齡B2	(22)	19		20
	08:55-09:45	百齡B1	(23)	22		23
	08:55-09:45	百齡B2	(24)	25		26
	09:50-10:40	百齡B1	(25)	28		29
	09:50-10:40	百齡B2	(26)	31		32
	10:45-11:35	百齡B1	(27)	34		35
	10:45-11:35	百齡B2	(28)	37		38
	11:40-12:30	百齡B1	(29)	1		4
	11:40-12:30	百齡B2	(30)	2		3
	12:35-13:25	百齡B1	(31)	5		8
	12:35-13:25	百齡B2	(32)	6		7
	13:30-14:20	百齡B1	(33)	11		9
	13:30-14:20	百齡B2	(34)	14		12
	14:25-15:15	百齡B1	(35)	17		15
	14:25-15:15	百齡B2	(36)	20		18
	15:20-16:10	百齡B1	(37)	23		21
	15:20-16:10	百齡B2	(38)	26		24
	16:15-17:05	百齡B1	(39)	29		27
	16:15-17:05	百齡B2	(40)	32		30

2022全國少年盃足球錦標賽 學校四年級組

日期	時間	場地	場次	隊名	成績	隊名
3月30日	08:55-09:45	百齡B1	(41)	35		33
	08:55-09:45	百齡B2	(42)	38		36
	12:35-13:25	百齡B1	(43)	I1		E2
	12:35-13:25	百齡B2	(44)	J1		F2
	13:30-14:20	百齡B1	(45)	K1		G2
	13:30-14:20	百齡B2	(46)	L1		H2
	14:25-15:15	百齡B1	(47)	B2		I2
	14:25-15:15	百齡B2	(48)	A2		J2
	15:20-16:10	百齡B1	(49)	D2		K2
	15:20-16:10	百齡B2	(50)	C2		L2
3月31日	08:00-08:50	百齡A1	(51)	(43)W		A1
	08:00-08:50	百齡A2	(52)	(44)W		B1
	08:55-09:45	百齡A1	(53)	(45)W		C1
	08:55-09:45	百齡A2	(54)	(46)W		D1
	09:50-10:40	百齡A1	(55)	(47)W		E1
	09:50-10:40	百齡A2	(56)	(48)W		F1
	10:45-11:35	百齡A1	(57)	(49)W		G1
	10:45-11:35	百齡A2	(58)	(50)W		H1
4月1日	13:30-14:20	百齡A1	(59)	(51)W		(53)W
	13:30-14:20	百齡A2	(60)	(52)W		(54)W
	14:25-15:15	百齡A1	(61)	(55)W		(57)W
	14:25-15:15	百齡A2	(62)	(56)W		(58)W
4月2日	11:40-12:30	迎風C1	(63)	(59)W		(61)W
	11:40-12:30	迎風C2	(64)	(60)W		(62)W
4月3日	11:40-12:30	迎風C1	(65)	季、殿軍賽(63)L		季、殿軍賽(64)L
	11:40-12:30	迎風C2	(66)	冠、亞軍賽(63)W		冠、亞軍賽(64)W

2022全國少年盃足球錦標賽 公開六年級組

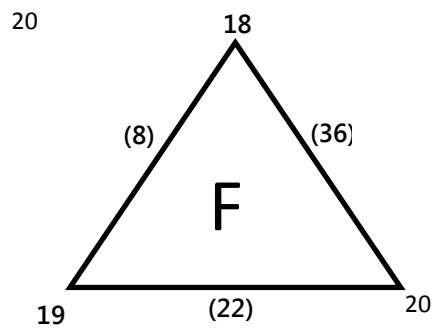
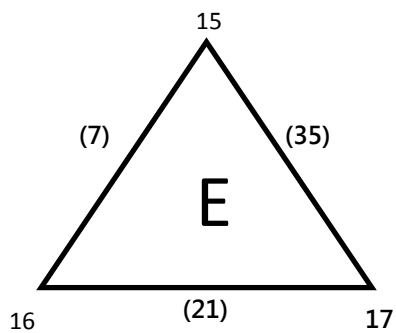
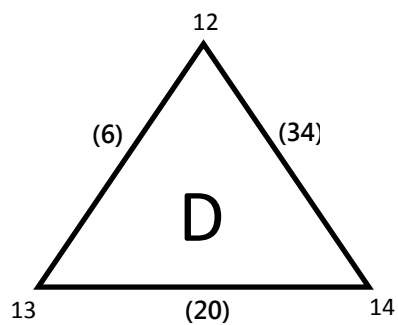
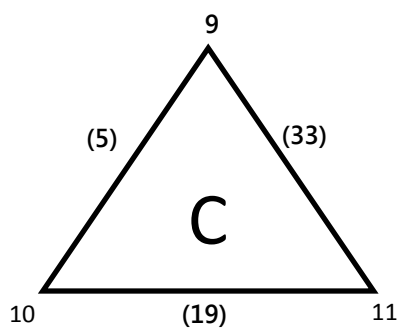
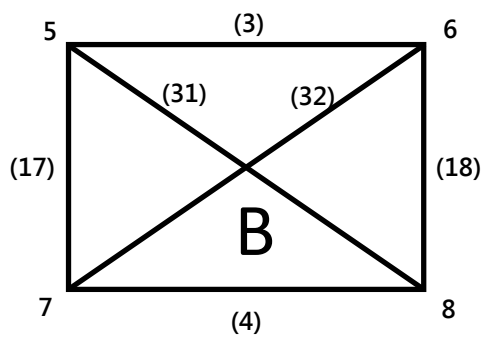
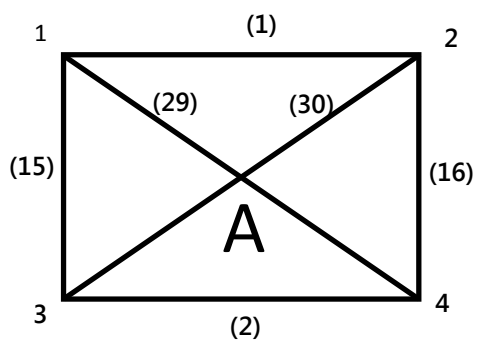

2022全國少年盃足球錦標賽 公開六年級組

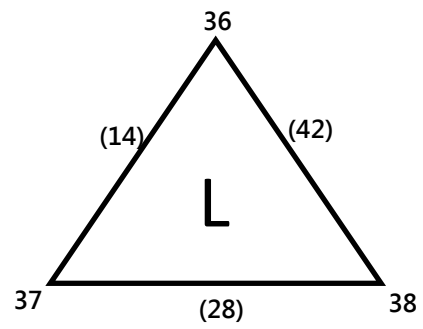
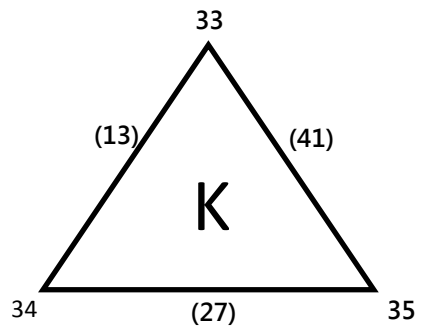
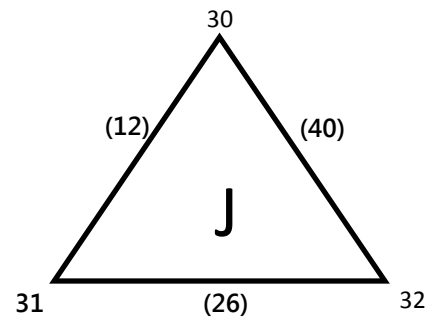
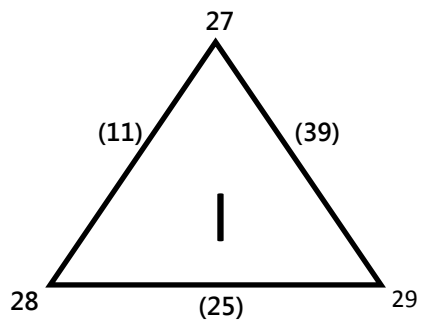
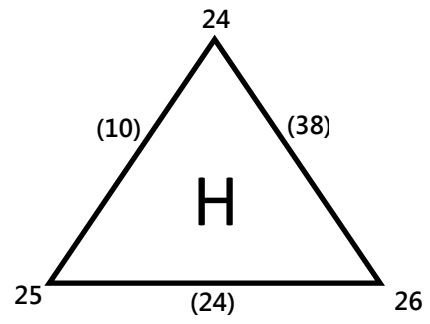
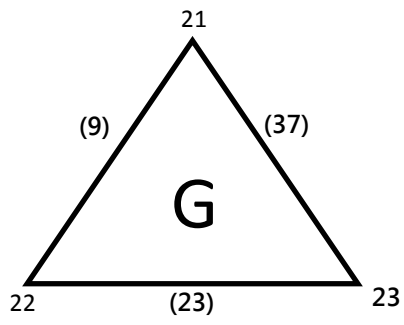

2022全國少年盃足球錦標賽 公開六年級組

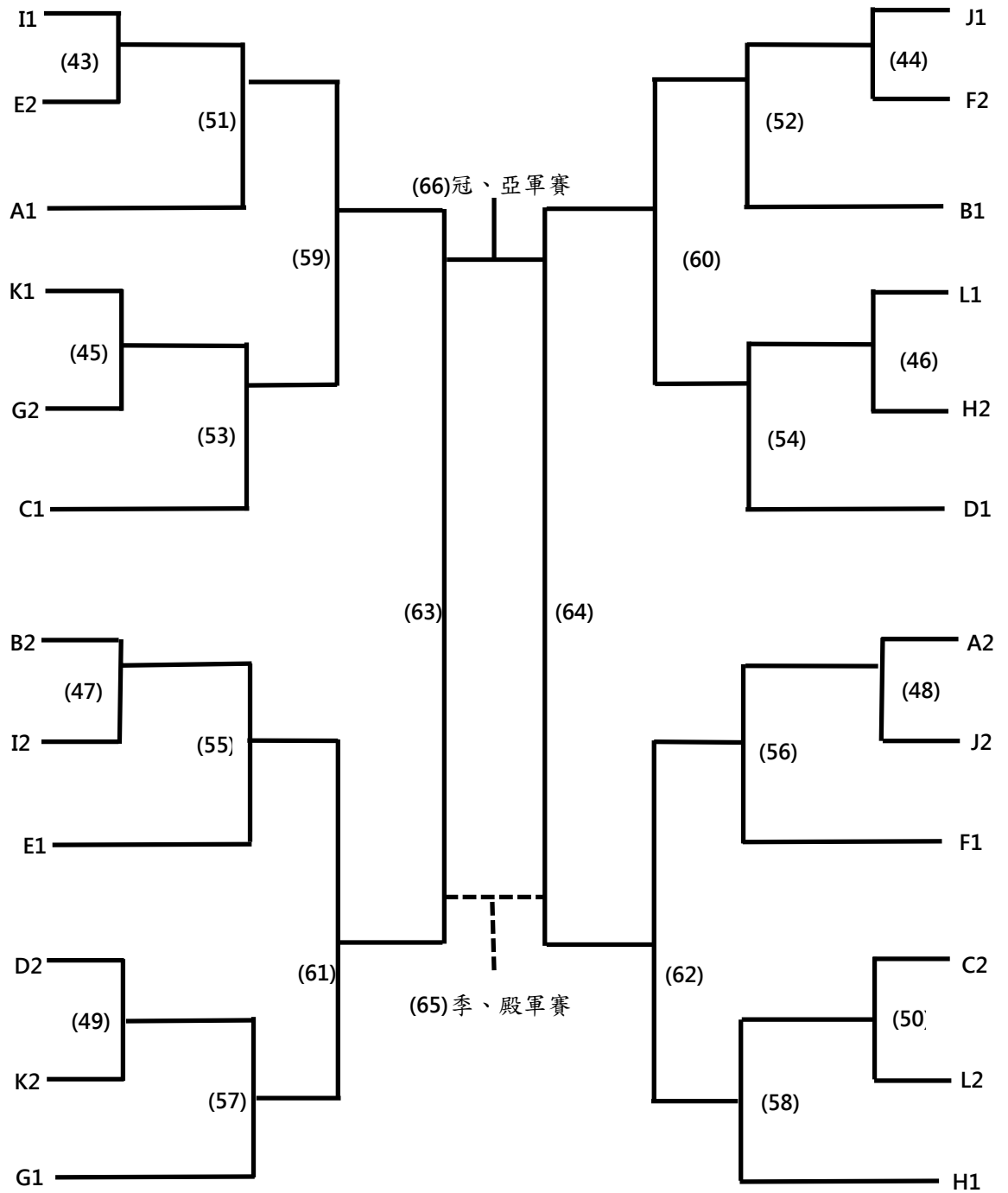



2022全國少年盃足球錦標賽 公開六年級組

日期	時間	場地	場次	隊名	成績	隊名
3月26日	08:00-08:50	迎風B1	(1)	1		2
	08:00-08:50	迎風B2	(2)	3		4
	08:55-09:45	迎風B1	(3)	5		6
	08:55-09:45	迎風B2	(4)	7		8
	09:50-10:40	迎風B1	(5)	9		10
	09:50-10:40	迎風B2	(6)	12		13
	10:45-11:35	迎風B1	(7)	15		16
	10:45-11:35	迎風B2	(8)	18		19
	11:40-12:30	迎風B1	(9)	21		22
	11:40-12:30	迎風B2	(10)	24		25
	12:35-13:25	迎風B1	(11)	27		28
	12:35-13:25	迎風B2	(12)	30		31
	13:30-14:20	迎風B1	(13)	33		34
	13:30-14:20	迎風B2	(14)	36		37
	14:25-15:15	迎風B1	(15)	3		1
	14:25-15:15	迎風B2	(16)	4		2
	15:20-16:10	迎風B1	(17)	7		5
	15:20-16:10	迎風B2	(18)	8		6
	16:15-17:05	迎風B1	(19)	10		11
	16:15-17:05	迎風B2	(20)	13		14
3月27日	08:00-08:50	迎風B1	(21)	16		17
	08:00-08:50	迎風B2	(22)	19		20
	08:55-09:45	迎風B1	(23)	22		23
	08:55-09:45	迎風B2	(24)	25		26
	09:50-10:40	迎風B1	(25)	28		29
	09:50-10:40	迎風B2	(26)	31		32
	10:45-11:35	迎風B1	(27)	34		35
	10:45-11:35	迎風B2	(28)	37		38
	11:40-12:30	迎風B1	(29)	1		4
	11:40-12:30	迎風B2	(30)	2		3
	12:35-13:25	迎風B1	(31)	5		8
	12:35-13:25	迎風B2	(32)	6		7
	13:30-14:20	迎風B1	(33)	11		9
	13:30-14:20	迎風B2	(34)	14		12
	14:25-15:15	迎風B1	(35)	17		15
	14:25-15:15	迎風B2	(36)	20		18
	15:20-16:10	迎風B1	(37)	23		21
	15:20-16:10	迎風B2	(38)	26		24
	16:15-17:05	迎風B1	(39)	29		27
	16:15-17:05	迎風B2	(40)	32		30

2022全國少年盃足球錦標賽 公開六年級組

日期	時間	場地	場次	隊名	成績	隊名
4月2日	09:50-10:40	迎風C1	(41)	35		33
	09:50-10:40	迎風C2	(42)	38		36
4月3日	08:00-08:50	迎風D1	(43)	I1		E2
	08:00-08:50	迎風D2	(44)	J1		F2
	08:55-09:45	迎風D1	(45)	K1		G2
	08:55-09:45	迎風D2	(46)	L1		H2
	09:50-10:40	迎風D1	(47)	B2		I2
	09:50-10:40	迎風D2	(48)	A2		J2
	10:45-11:35	迎風D1	(49)	D2		K2
	10:45-11:35	迎風D2	(50)	C2		L2
4月4日	08:55-09:45	迎風D1	(51)	(43)W		A1
	08:55-09:45	迎風D2	(52)	(44)W		B1
	09:50-10:40	迎風D1	(53)	(45)W		C1
	09:50-10:40	迎風D2	(54)	(46)W		D1
	10:45-11:35	迎風D1	(55)	(47)W		E1
	10:45-11:35	迎風D2	(56)	(48)W		F1
	11:40-12:30	迎風D1	(57)	(49)W		G1
	11:40-12:30	迎風D2	(58)	(50)W		H1
	15:20-16:10	迎風D1	(59)	(51)W		(53)W
	15:20-16:10	迎風D2	(60)	(52)W		(54)W
	16:15-17:05	迎風D1	(61)	(55)W		(57)W
	16:15-17:05	迎風D2	(62)	(56)W		(58)W
4月5日	10:45-11:35	迎風C1	(63)	(59)W		(61)W
	10:45-11:35	迎風C2	(64)	(60)W		(62)W
	14:25-15:15	迎風C1	(65)	季、殿軍賽(63)L		季、殿軍賽(64)L
	14:25-15:15	迎風C2	(66)	冠、亞軍賽(63)W		冠、亞軍賽(64)W

2022全國少年盃足球錦標賽 公開五年級組

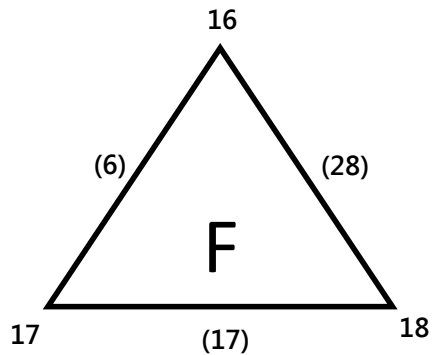
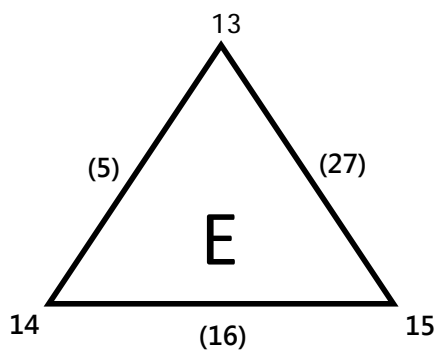
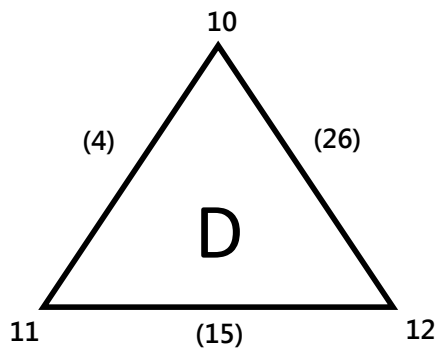
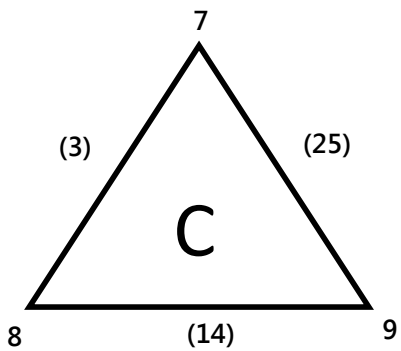
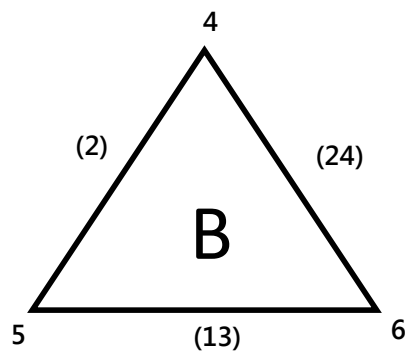
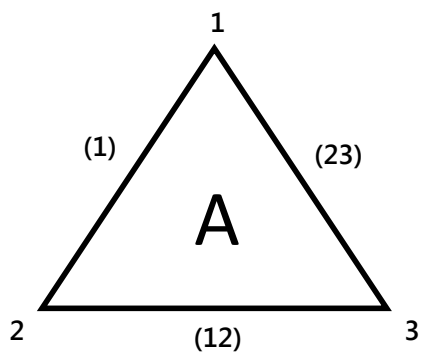

2022全國少年盃足球錦標賽 公開五年級組

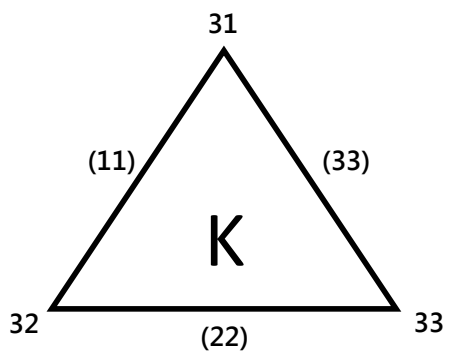
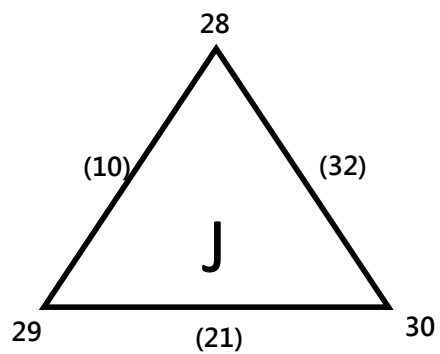
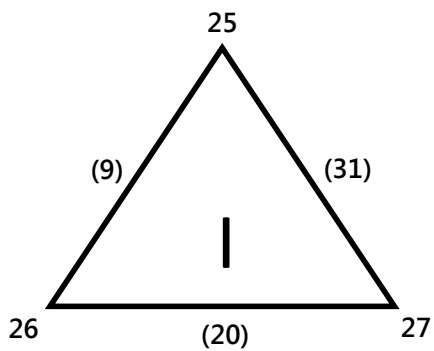
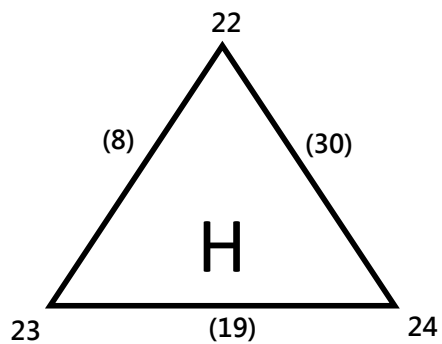
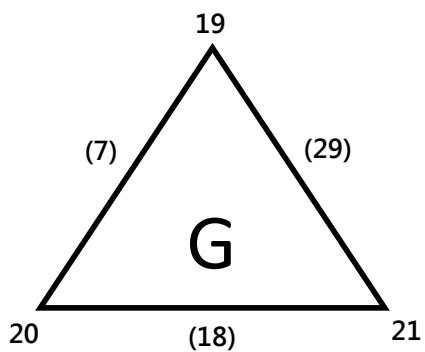

2022全國少年盃足球錦標賽 公開五年級組

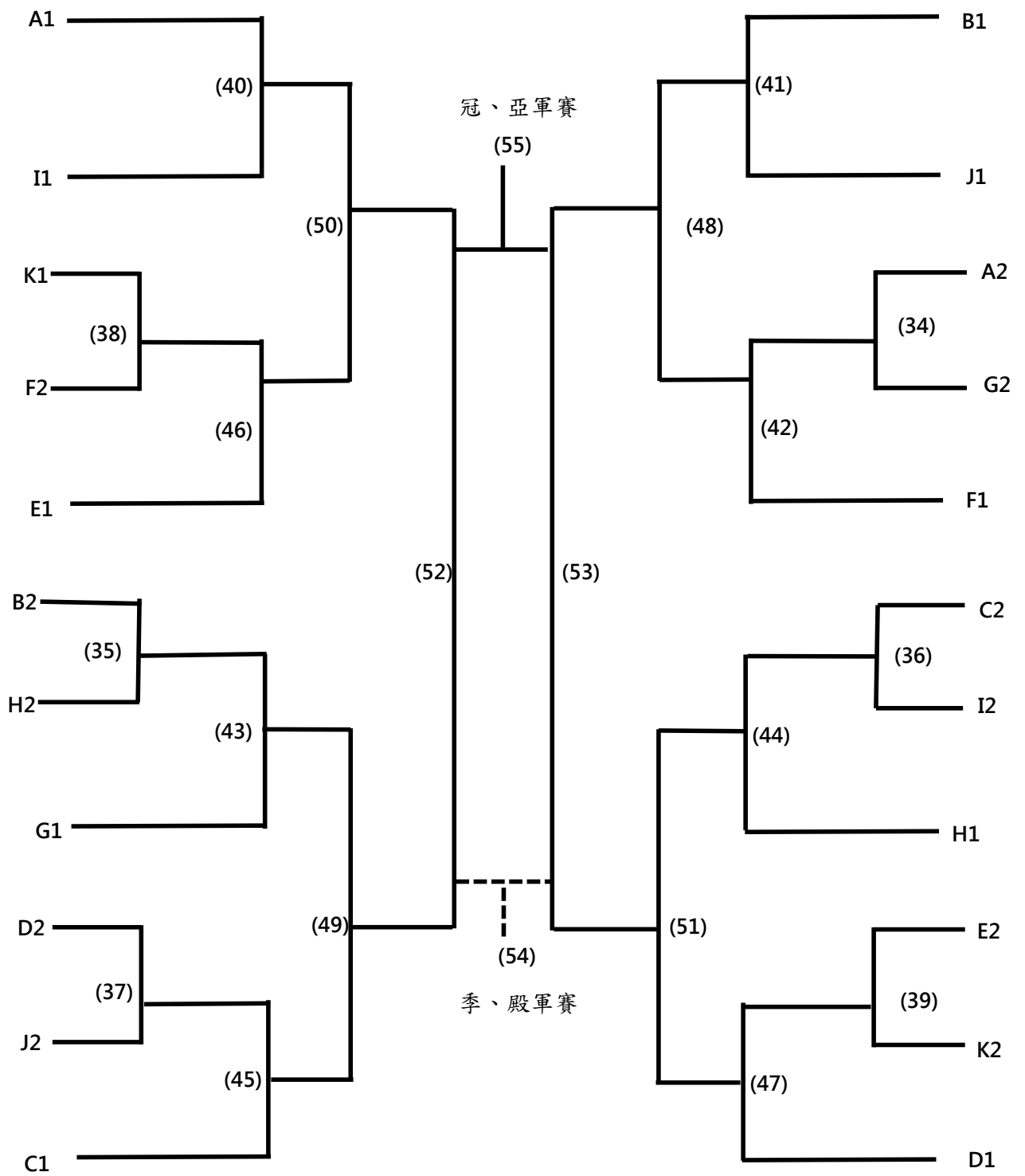

2022全國少年盃足球錦標賽 公開五年級組

日期	時間	場地	場次	隊名	成績	隊名
3月26日	08:55-09:45	百齡B1	(1)	1		2
	08:55-09:45	百齡B2	(2)	4		5
	09:50-10:40	百齡B1	(3)	7		8
	09:50-10:40	百齡B2	(4)	10		11
	10:45-11:35	百齡B1	(5)	13		14
	10:45-11:35	百齡B2	(6)	16		17
	11:40-12:30	百齡B1	(7)	19		20
	11:40-12:30	百齡B2	(8)	22		23
	12:35-13:25	百齡B1	(9)	25		26
	12:35-13:25	百齡B2	(10)	28		29
	13:30-14:20	百齡B1	(11)	31		32
	13:30-14:20	百齡B2	(12)	2		3
	14:25-15:15	百齡B1	(13)	5		6
	14:25-15:15	百齡B2	(14)	8		9
	15:20-16:10	百齡B1	(15)	11		12
	15:20-16:10	百齡B2	(16)	14		15
	16:15-17:05	百齡B1	(17)	17		18
	16:15-17:05	百齡B2	(18)	20		21
3月27日	08:55-09:45	百齡B1	(19)	23		24
	08:55-09:45	百齡B2	(20)	26		27
	09:50-10:40	百齡B1	(21)	29		30
	09:50-10:40	百齡B2	(22)	32		33
	10:45-11:35	百齡B1	(23)	3		1
	10:45-11:35	百齡B2	(24)	6		4
	11:40-12:30	百齡B1	(25)	9		7
	11:40-12:30	百齡B2	(26)	12		10
	12:35-13:25	百齡B1	(27)	15		13
	12:35-13:25	百齡B2	(28)	18		16
	13:30-14:20	百齡B1	(29)	21		19
	13:30-14:20	百齡B2	(30)	24		22
	14:25-15:15	百齡B1	(31)	27		25
	14:25-15:15	百齡B2	(32)	30		28
	15:20-16:10	百齡B1	(33)	33		31
	15:20-16:10	百齡B2	(34)	A2		G2
	16:15-17:05	百齡B1	(35)	B2		H2
	16:15-17:05	百齡B2	(36)	C2		I2

2022全國少年盃足球錦標賽 公開五年級組

日期	時間	場地	場次	隊名	成績	隊名
4月3日	08:00-08:50	迎風C1	(37)	D2		J2
	08:00-08:50	迎風C2	(38)	K1		F2
	08:55-09:45	迎風C1	(39)	E2		K2
	08:55-09:45	迎風C2	(40)	A1		I1
	14:25-15:15	迎風D1	(41)	B1		J1
	14:25-15:15	迎風D2	(42)	(34)W		F1
	15:20-16:10	迎風D1	(43)	(35)W		G1
	15:20-16:10	迎風D2	(44)	(36)W		H1
	16:15-17:05	迎風D1	(45)	(37)W		C1
	16:15-17:05	迎風D2	(46)	(38)W		E1
	16:15-17:05	迎風C1	(47)	(39)W		D1
4月4日	12:35-13:25	迎風D1	(48)	(41)W		(42)W
	12:35-13:25	迎風D2	(49)	(43)W		(45)W
	13:30-14:20	迎風D1	(50)	(40)W		(46)W
	13:30-14:20	迎風D2	(51)	(44)W		(47)W
4月5日	09:50-10:40	迎風C1	(52)	(50)W		(49)W
	09:50-10:40	迎風C2	(53)	(48)W		(51)W
	13:30-14:20	迎風C1	(54)	季、殿軍賽(52)L		季、殿軍賽(53)L
	13:30-14:20	迎風C2	(55)	冠、亞軍賽(52)W		冠、亞軍賽(53)W

2022全國少年盃足球錦標賽 公開四年級組

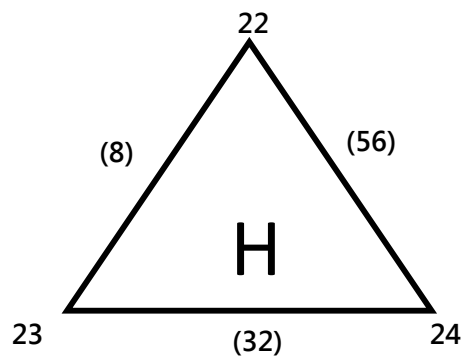
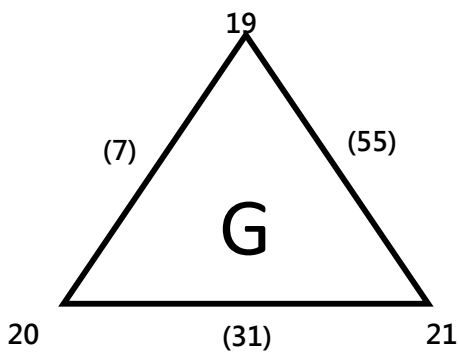
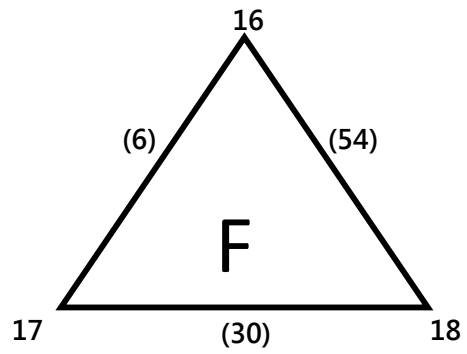
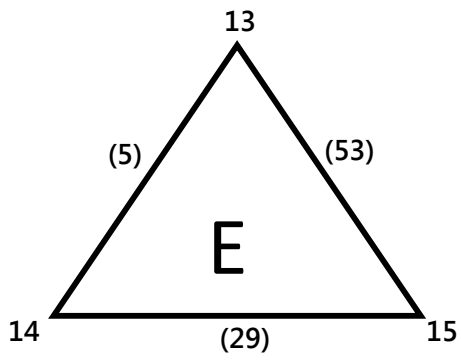
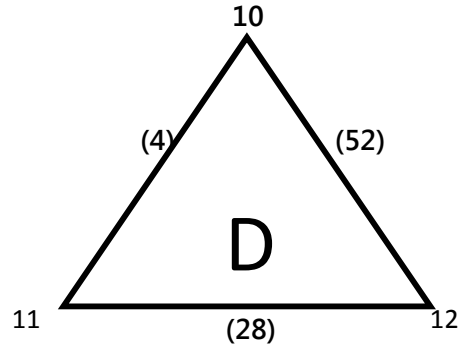
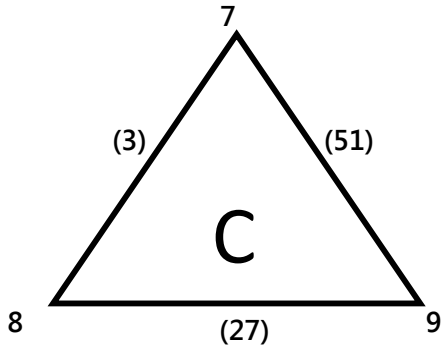
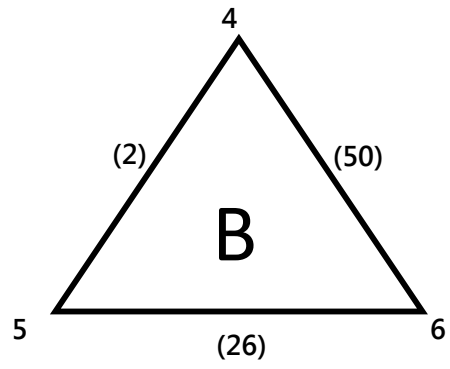
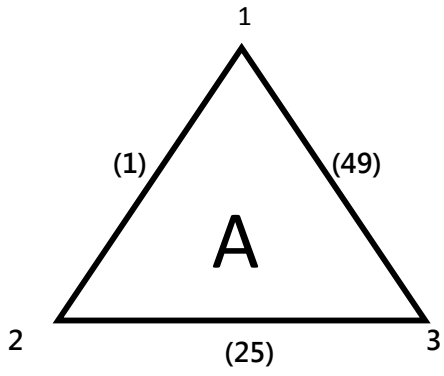



2022全國少年盃足球錦標賽 公開四年級組

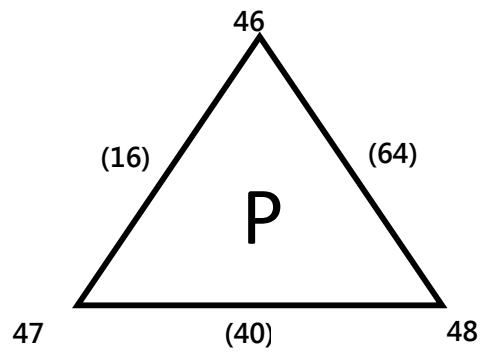
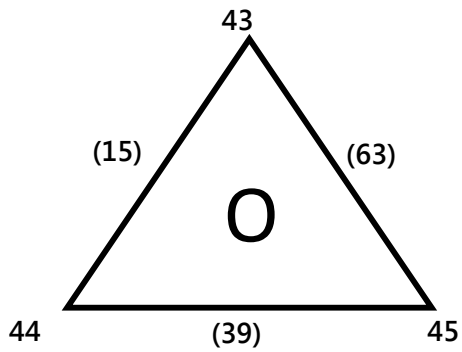
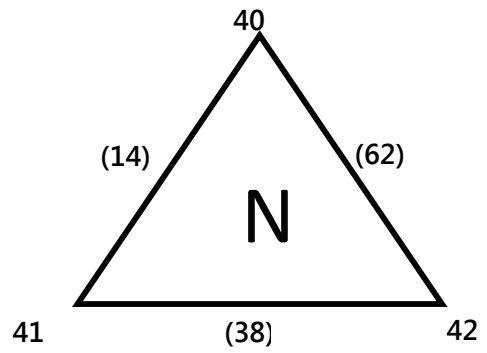
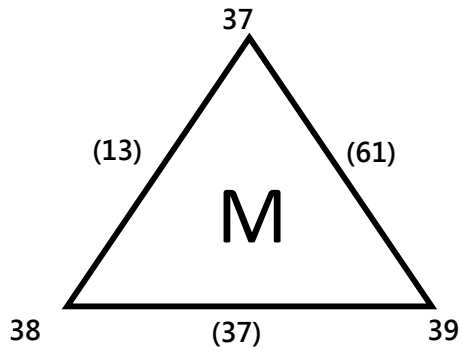
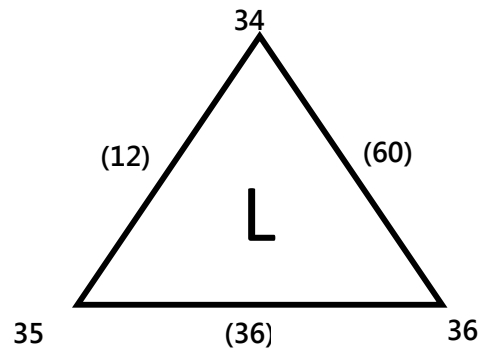
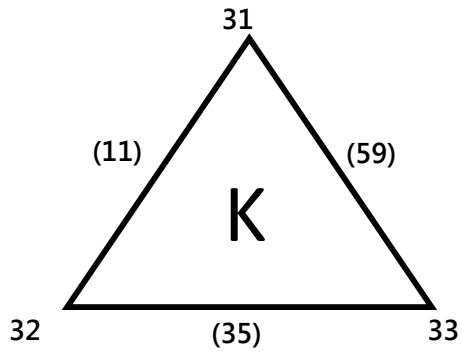
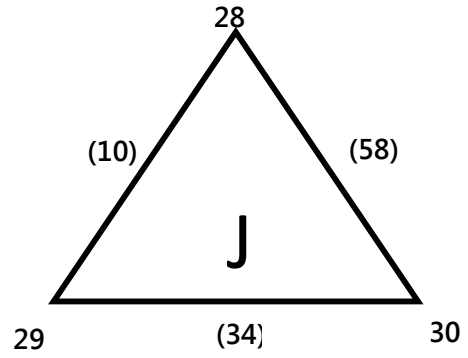
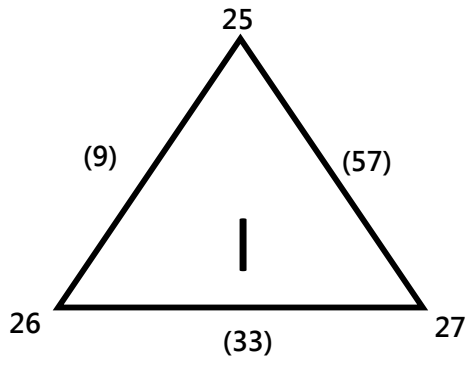

2022全國少年盃足球錦標賽 公開四年級組

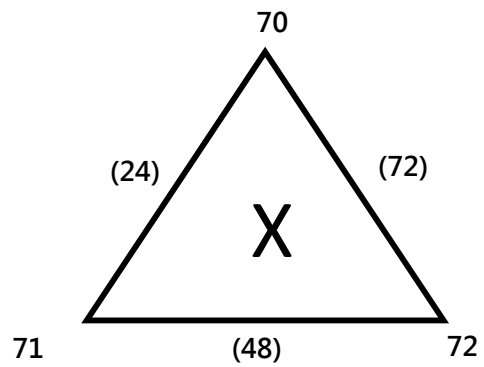
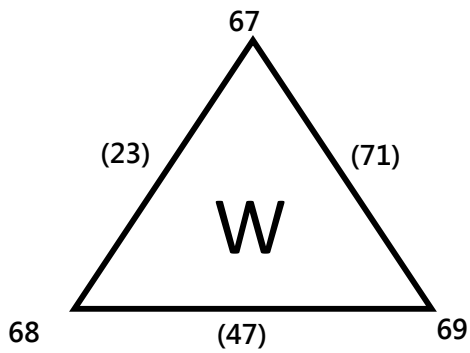
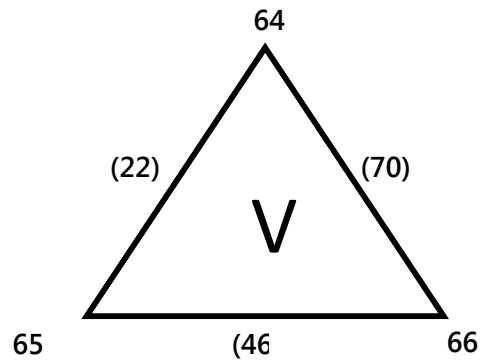
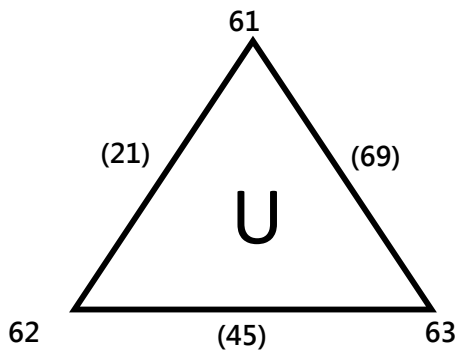
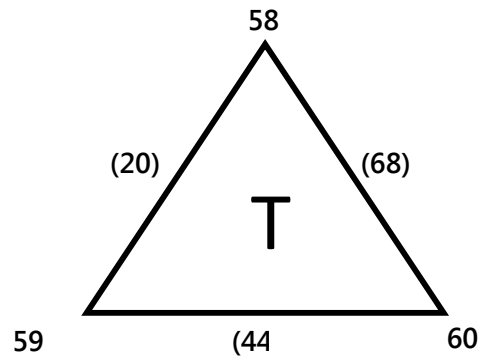
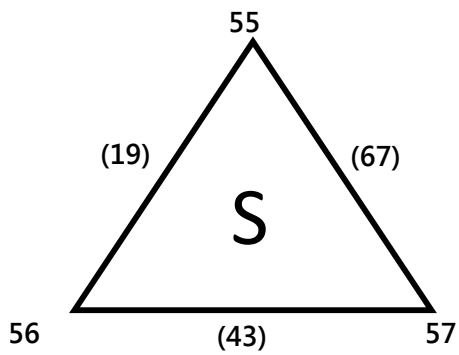
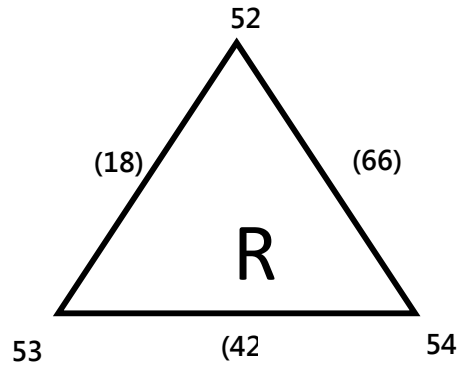
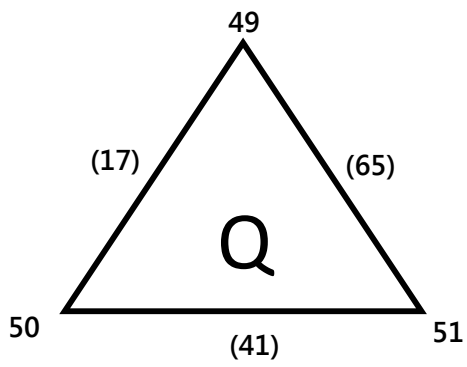

2022全國少年盃足球錦標賽 公開四年級組

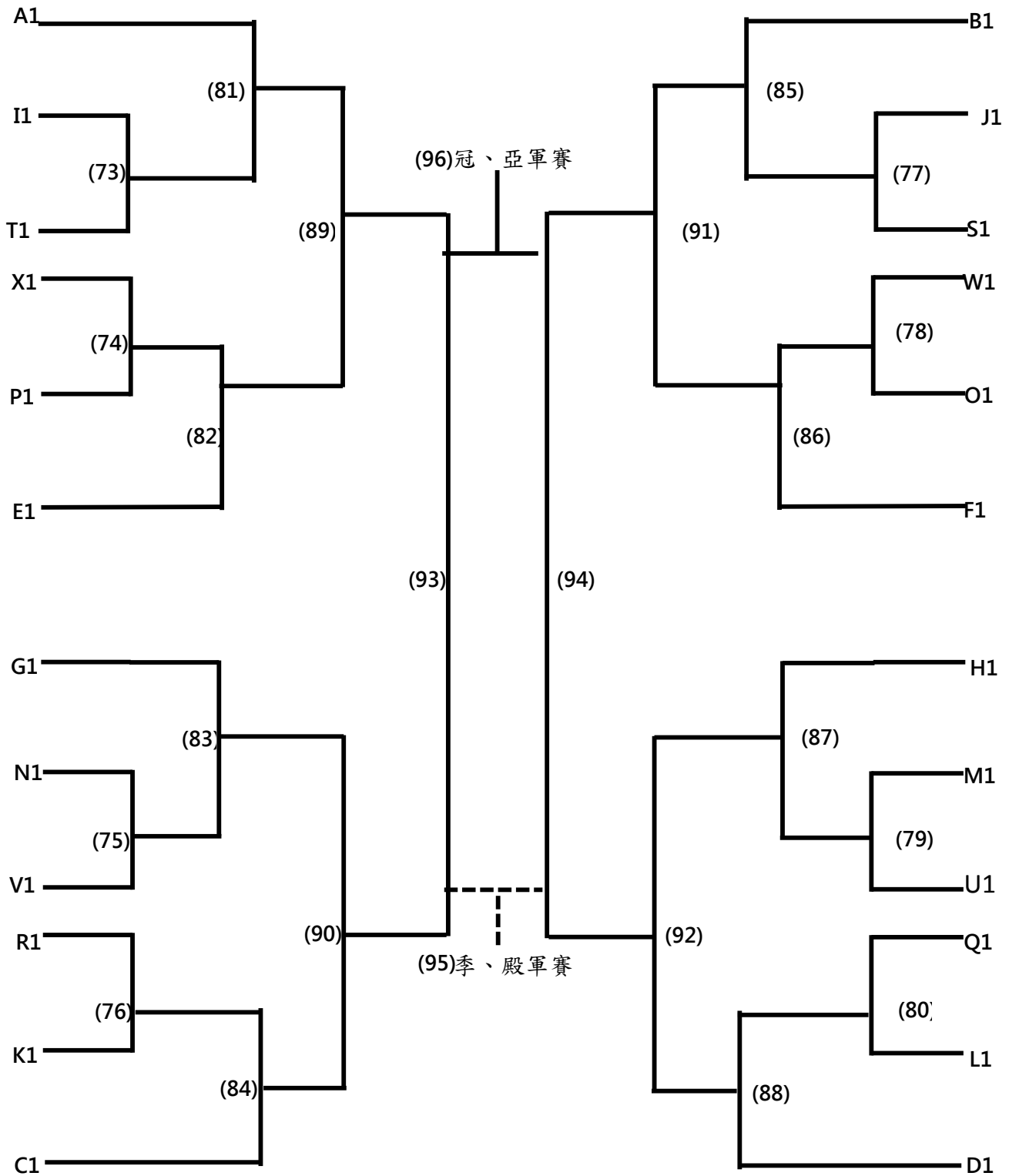

## 2022全國少年盃足球錦標賽 公開四年級組

日期	時間	場地	場次	隊名	成績	隊名
3月26日	08:00-08:50	百齡B1	(1)	1		2
	08:00-08:50	百齡B2	(2)	4		5
	08:00-08:50	百齡A1	(3)	7		8
	08:00-08:50	百齡A2	(4)	10		11
	08:55-09:45	百齡A1	(5)	13		14
	08:55-09:45	百齡A2	(6)	16		17
	09:50-10:40	百齡A1	(7)	19		20
	09:50-10:40	百齡A2	(8)	22		23
	10:45-11:35	百齡A1	(9)	25		26
	10:45-11:35	百齡A2	(10)	28		29
	11:40-12:30	百齡A1	(11)	31		32
	11:40-12:30	百齡A2	(12)	34		35
	12:35-13:25	百齡A1	(13)	37		38
	12:35-13:25	百齡A2	(14)	40		41
	13:30-14:20	百齡A1	(15)	43		44
	13:30-14:20	百齡A2	(16)	46		47
	14:25-15:15	百齡A1	(17)	49		50
	14:25-15:15	百齡A2	(18)	52		53
	15:20-16:10	百齡A1	(19)	55		56
	15:20-16:10	百齡A2	(20)	58		59
	16:15-17:05	百齡A1	(21)	61		62
	16:15-17:05	百齡A2	(22)	64		65
	17:10-18:00	百齡A1	(23)	67		68
	17:10-18:00	百齡A2	(24)	70		71
3月27日	08:00-08:50	百齡B1	(25)	2		3
	08:00-08:50	百齡B2	(26)	5		6
	08:00-08:50	百齡A1	(27)	8		9
	08:00-08:50	百齡A2	(28)	11		12
	08:55-09:45	百齡A1	(29)	14		15
	08:55-09:45	百齡A2	(30)	17		18
	09:50-10:40	百齡A1	(31)	20		21
	09:50-10:40	百齡A2	(32)	23		24
	10:45-11:35	百齡A1	(33)	26		27
	10:45-11:35	百齡A2	(34)	29		30
	11:40-12:30	百齡A1	(35)	32		33
	11:40-12:30	百齡A2	(36)	35		36
	12:35-13:25	百齡A1	(37)	38		39
	12:35-13:25	百齡A2	(38)	41		42
	13:30-14:20	百齡A1	(39)	44		45
	13:30-14:20	百齡A2	(40)	47		48
	14:25-15:15	百齡A1	(41)	50		51
	14:25-15:15	百齡A2	(42)	53		54
	15:20-16:10	百齡A1	(43)	56		57
	15:20-16:10	百齡A2	(44)	59		60
	16:15-17:05	百齡A1	(45)	62		63
	16:15-17:05	百齡A2	(46)	65		66
	17:10-18:00	百齡A1	(47)	68		69
	17:10-18:00	百齡A2	(48)	71		72

2022全國少年盃足球錦標賽 公開四年級組

日期	時間	場地	場次	隊名	成績	隊名
4月2日	08:00-08:50	迎風C1	(49)	3		1
	08:00-08:50	迎風C2	(50)	6		4
	08:00-08:50	迎風D1	(51)	9		7
	08:00-08:50	迎風D2	(52)	12		10
	08:55-09:45	迎風C1	(53)	15		13
	08:55-09:45	迎風C2	(54)	18		16
	08:55-09:45	迎風D1	(55)	21		19
	08:55-09:45	迎風D2	(56)	24		22
	09:50-10:40	迎風D1	(57)	27		25
	09:50-10:40	迎風D2	(58)	30		28
	10:45-11:35	迎風D1	(59)	33		31
	10:45-11:35	迎風D2	(60)	36		34
	11:40-12:30	迎風D1	(61)	39		37
	11:40-12:30	迎風D2	(62)	42		40
	12:35-13:25	迎風D1	(63)	45		43
	12:35-13:25	迎風D2	(64)	48		46
	13:30-14:20	迎風D1	(65)	51		49
	13:30-14:20	迎風D2	(66)	54		52
	14:25-15:15	迎風D1	(67)	57		55
	14:25-15:15	迎風D2	(68)	60		58
	15:20-16:10	迎風D1	(69)	63		61
	15:20-16:10	迎風D2	(70)	66		64
16:15-17:05	迎風D1	(71)	69		67	
16:15-17:05	迎風D2	(72)	72		70	
4月3日	09:50-10:40	迎風C1	(73)	I1		T1
	09:50-10:40	迎風C2	(74)	X1		P1
	11:40-12:30	迎風D1	(75)	N1		V1
	11:40-12:30	迎風D2	(76)	R1		K1
	12:35-13:25	迎風D1	(77)	J1		S1
	12:35-13:25	迎風D2	(78)	W1		O1
	13:30-14:20	迎風D1	(79)	M1		U1
13:30-14:20	迎風D2	(80)	Q1		L1	
4月4日	08:55-09:45	迎風C1	(81)	A1		(73)W
	08:55-09:45	迎風C2	(82)	E1		(74)W
	09:50-10:40	迎風C1	(83)	G1		(75)W
	09:50-10:40	迎風C2	(84)	C1		(76)W
	10:45-11:35	迎風C1	(85)	B1		(77)W
	10:45-11:35	迎風C2	(86)	F1		(78)W
	11:40-12:30	迎風C1	(87)	H1		(79)W
	11:40-12:30	迎風C2	(88)	D1		(80)W
	15:20-16:10	迎風C1	(89)	(81)W		(82)W
	15:20-16:10	迎風C2	(90)	(83)W		(84)W
	16:15-17:05	迎風C1	(91)	(85)W		(86)W
16:15-17:05	迎風C2	(92)	(87)W		(88)W	
4月5日	08:55-09:45	迎風C1	(93)	(89)W		(90)W
	08:55-09:45	迎風C2	(94)	(91)W		(92)W
	12:35-13:25	迎風C1	(95)	季、殿軍賽 (93)L		季、殿軍賽 (94)L
	12:35-13:25	迎風C2	(96)	冠、亞軍賽(93)W		冠、亞軍賽(94)W

2022全國少年盃足球錦標賽 女子六年級組

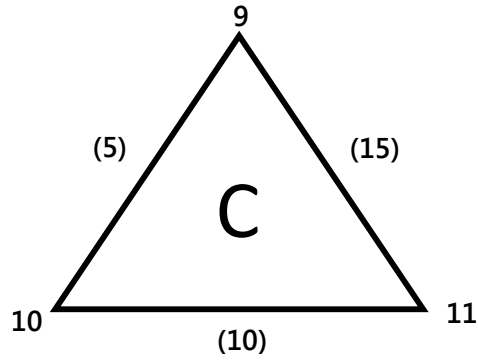
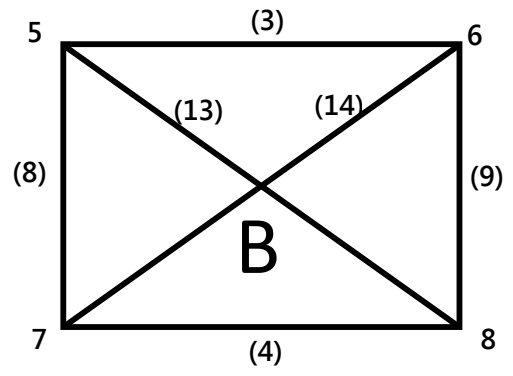
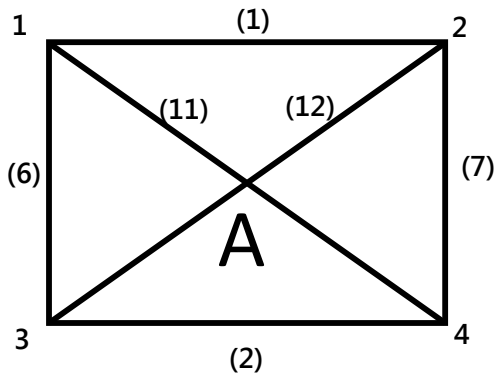

(21)冠、亞軍賽

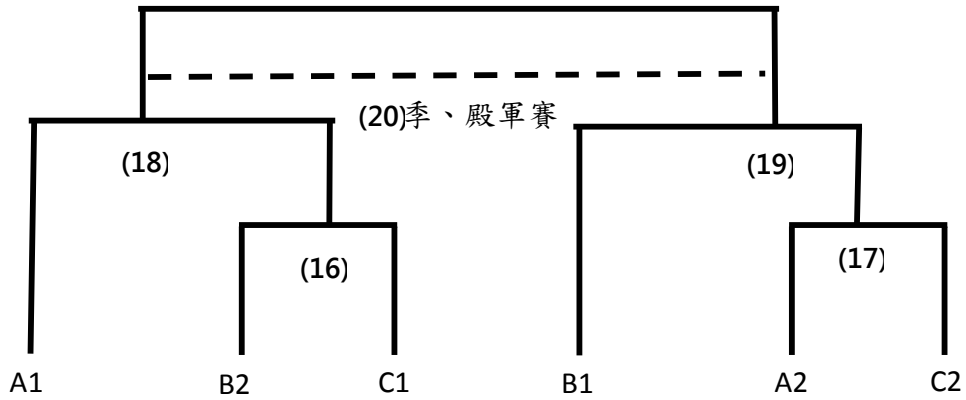

## 2022全國少年盃足球錦標賽 女子六年級組

日期	時間	場地	場次	隊名	成績	隊名
3月30日	09:50-10:40	百齡B1	(1)	1		2
	09:50-10:40	百齡B2	(2)	3		4
	10:45-11:35	百齡B1	(3)	5		6
	10:45-11:35	百齡B2	(4)	7		8
	11:40-12:30	百齡B1	(5)	9		10
3月31日	08:00-08:50	百齡B1	(6)	3		1
	08:00-08:50	百齡B2	(7)	4		2
	08:55-09:45	百齡B1	(8)	7		5
	08:55-09:45	百齡B2	(9)	8		6
	09:50-10:40	百齡B1	(10)	10		11
	14:25-15:15	百齡B2	(11)	1		4
	14:25-15:15	百齡B1	(12)	2		3
	15:20-16:10	百齡B2	(13)	5		8
	15:20-16:10	百齡B1	(14)	6		7
4月1日	16:15-17:05	百齡B2	(15)	11		9
	12:35-13:25	百齡B1	(16)	B2		C1
4月2日	12:35-13:25	百齡B2	(17)	A2		C2
	14:25-15:15	迎風C1	(18)	A1		(16)W
4月3日	14:25-15:15	迎風C2	(19)	B1		(17)W
	14:25-15:15	迎風C1	(20)	季、殿軍賽(20)L		季、殿軍賽(21)L
	14:25-15:15	迎風C2	(21)	冠、亞軍賽(20)W		冠、亞軍賽(21)W

2022全國少年盃足球錦標賽 女子五年級組

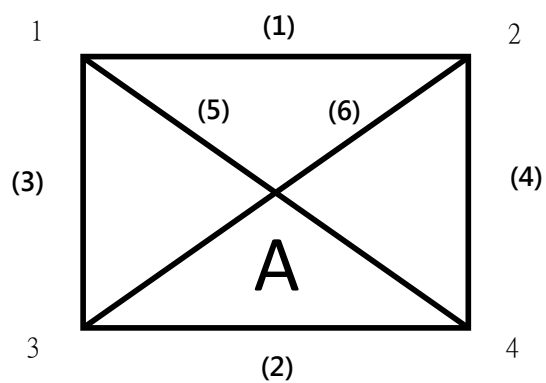

日期	時間	場地	場次	隊名	成績	隊名
4月2日	10:45-11:35	迎風C1	(1)	1		2
	10:45-11:35	迎風C2	(2)	3		4
	16:15-17:05	迎風C1	(3)	3		1
	16:15-17:05	迎風C2	(4)	4		2
4月3日	10:45-11:35	迎風C1	(5)	1		4
	10:45-11:35	迎風C2	(6)	2		3



2022全國少年盃足球錦標賽 女子四年級組

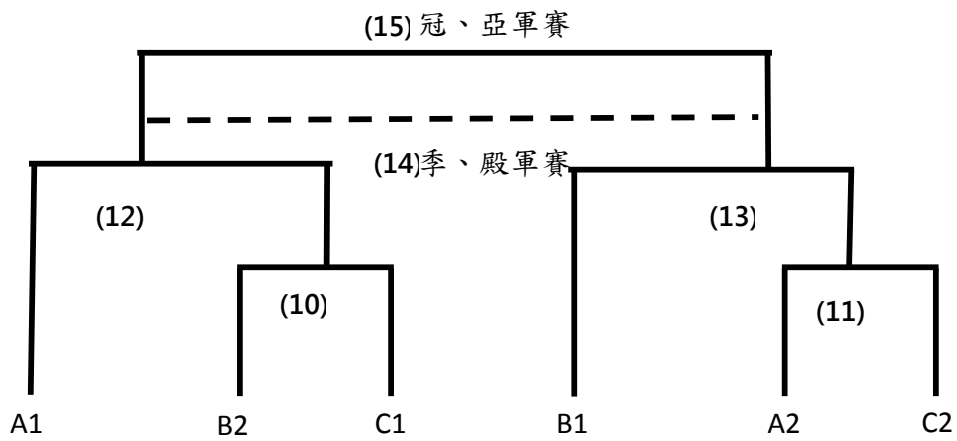
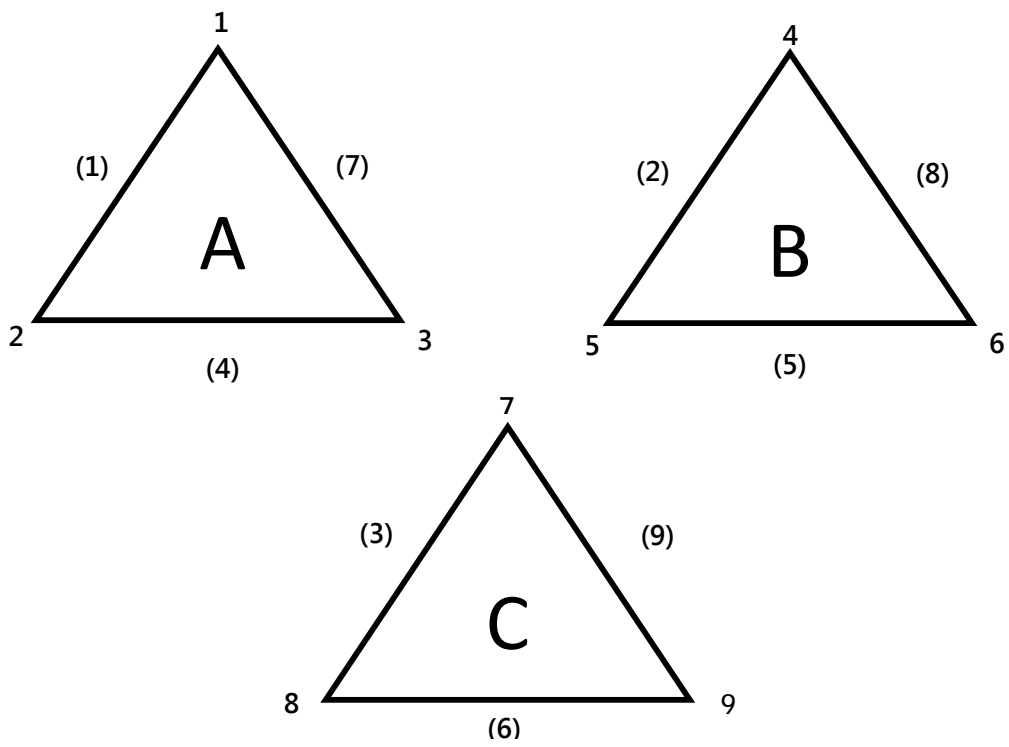

2022全國少年盃足球錦標賽 女子四年級組

日期	時間	場地	場次	隊名	成績	隊名
3月31日	11:40-12:30	百齡A1	(1)	1		2
	11:40-12:30	百齡A2	(2)	4		5
	12:35-13:25	百齡A1	(3)	7		8
	15:20-16:10	百齡A2	(4)	2		3
	16:15-17:05	百齡A1	(5)	5		6
	16:15-17:05	百齡A2	(6)	8		9
4月1日	08:55-09:45	百齡B1	(7)	3		1
	08:55-09:45	百齡B2	(8)	6		4
	09:50-10:40	百齡B1	(9)	9		7
	13:30-14:20	百齡B1	(10)	B2		C1
	13:30-14:20	百齡B2	(11)	A2		C2
4月2日	12:35-13:25	迎風C1	(12)	A1		(10)W
	12:35-13:25	迎風C2	(13)	B1		(11)W
4月3日	12:35-13:25	迎風C1	(14)	季、殿軍賽(12)L		季、殿軍賽(13)L
	12:35-13:25	迎風C2	(15)	冠、亞軍賽(12)W		冠、亞軍賽(13)W