

2020全國少年盃足球錦標賽 學校組四年級
臺中市朝馬專用足球場

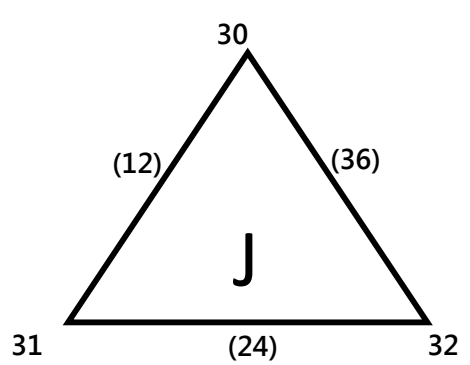

2020全國少年盃足球錦標賽 學校組四年級

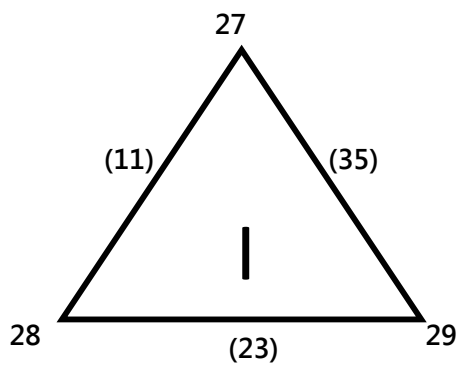
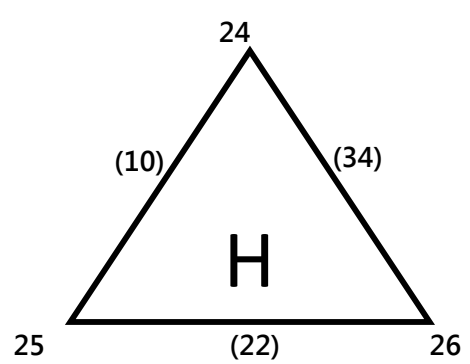
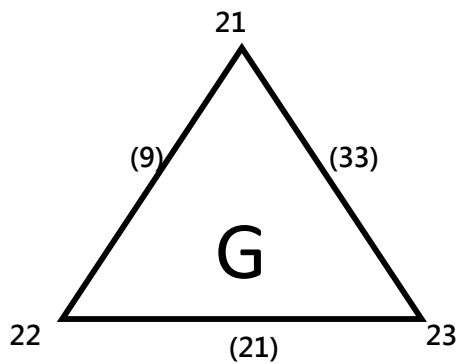
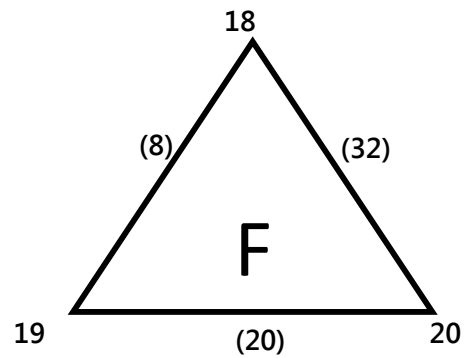
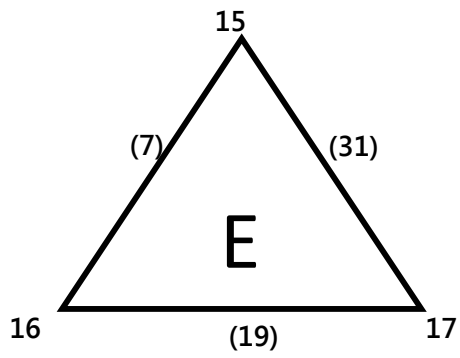
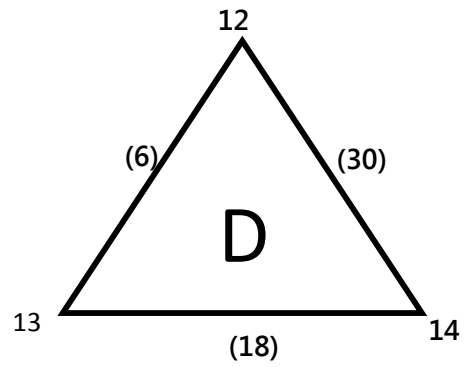
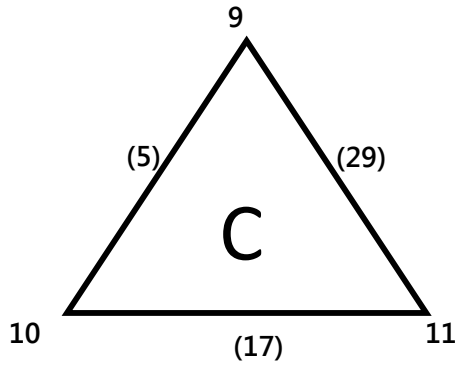
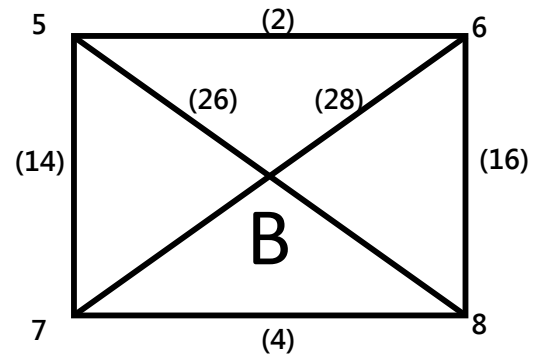
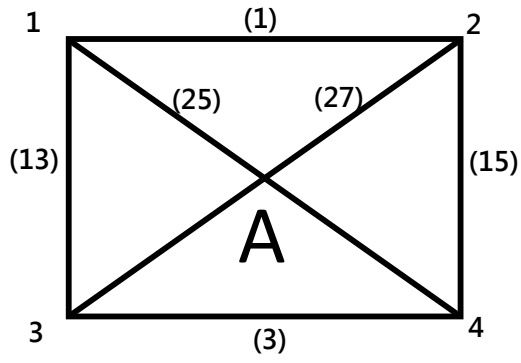
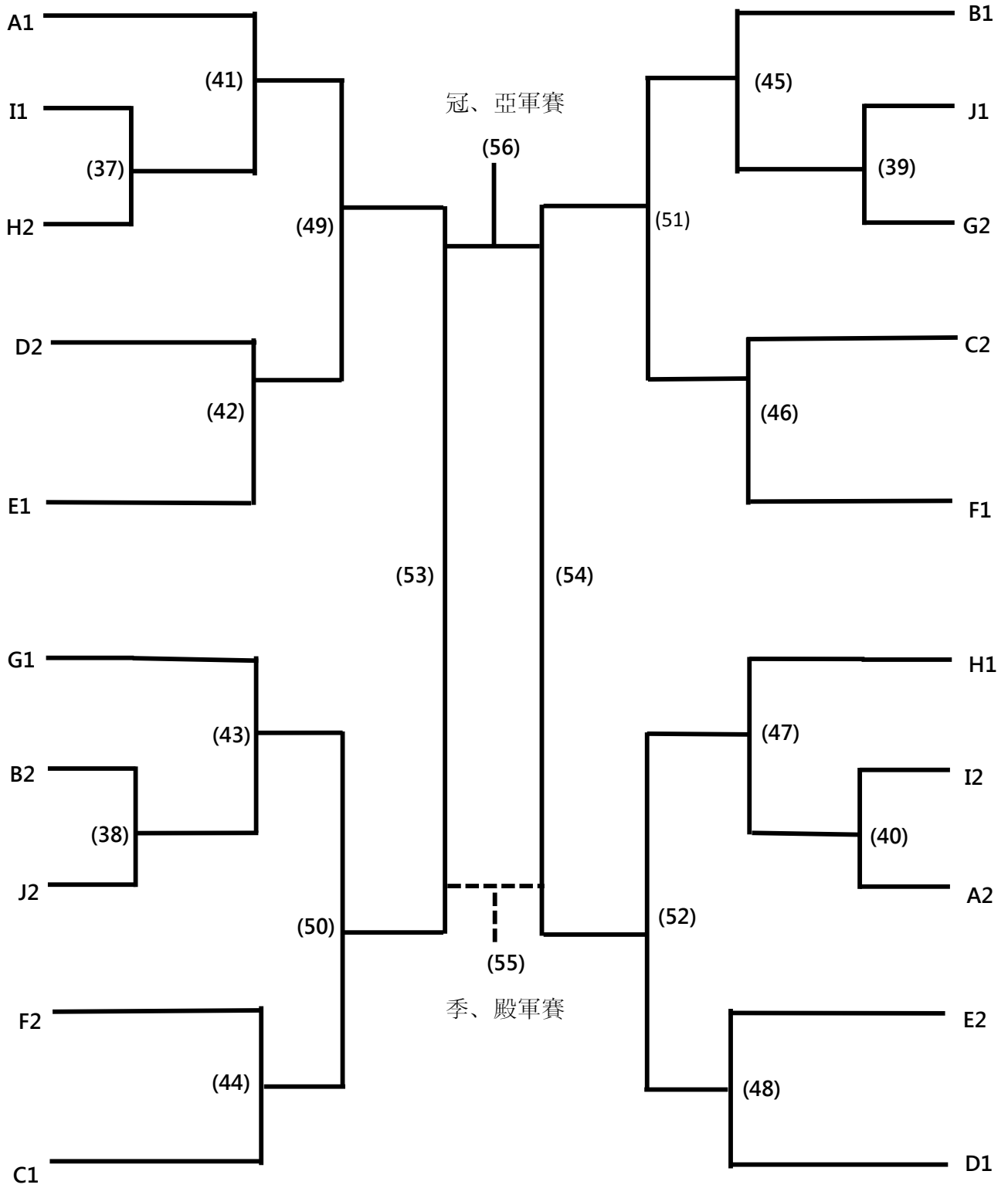

2020全國少年盃足球錦標賽 學校組四年級

臺中市朝馬專用足球場

日期	時間	場地	場次	隊名	成績	隊名
6月8日	08:00-09:00	A	(1)	1		2
	08:00-09:00	B	(2)	5		6
	08:00-09:00	C	(3)	3		4
	08:00-09:00	D	(4)	7		8
	09:30-10:30	A	(5)	9		10
	09:30-10:30	B	(6)	12		13
	09:30-10:30	C	(7)	15		16
	09:30-10:30	D	(8)	18		19
	11:00-12:00	A	(9)	21		22
	11:00-12:00	B	(10)	24		25
	11:00-12:00	C	(11)	27		28
	11:00-12:00	D	(12)	30		31
	12:30-13:30	A	(13)	3		1
	12:30-13:30	B	(14)	7		5
	12:30-13:30	C	(15)	4		2
	12:30-13:30	D	(16)	8		6
	14:00-15:00	A	(17)	10		11
	14:00-15:00	B	(18)	13		14
	14:00-15:00	C	(19)	16		17
	14:00-15:00	D	(20)	19		20
	15:30-16:30	A	(21)	22		23
	15:30-16:30	B	(22)	25		26
	15:30-16:30	C	(23)	28		29
	15:30-16:30	D	(24)	31		32
6月9日	12:30-13:30	A	(25)	1		4
	12:30-13:30	B	(26)	5		8
	12:30-13:30	C	(27)	2		3
	12:30-13:30	D	(28)	6		7
	14:00-15:00	A	(29)	11		9
	14:00-15:00	B	(30)	14		12
	14:00-15:00	C	(31)	17		15
	14:00-15:00	D	(32)	20		18
	15:30-16:30	A	(33)	23		21
	15:30-16:30	B	(34)	26		24
	15:30-16:30	C	(35)	29		27
	15:30-16:30	D	(36)	32		30

2020全國少年盃足球錦標賽 學校組四年級

臺中市朝馬專用足球場

日期	時間	場地	場次	隊名	成績	隊名
6月10日	12:30-13:30	A	(37)	I1		H2
	12:30-13:30	B	(38)	B2		J2
	12:30-13:30	C	(39)	J1		G2
	12:30-13:30	D	(40)	I2		A2
6月11日	08:00-09:00	A	(41)	A1		(37)W
	08:00-09:00	B	(42)	D2		E1
	08:00-09:00	C	(43)	G1		(38)W
	08:00-09:00	D	(44)	F2		C1
	09:30-10:30	A	(45)	B1		(39)W
	09:30-10:30	B	(46)	C2		F1
	09:30-10:30	C	(47)	H1		(40)W
	09:30-10:30	D	(48)	E2		D1
	14:00-15:00	A	(49)	(41)W		(42)W
	14:00-15:00	B	(50)	(43)W		(44)W
	14:00-15:00	C	(51)	(45)W		(46)W
	14:00-15:00	D	(52)	(47)W		(48)W
6月12日	09:30-10:30	A	(53)	(49)W		(50)W
	09:30-10:30	B	(54)	(51)W		(52)W
	14:00-15:00	A	(55)	季、殿軍賽(53)L		季、殿軍賽(54)L
	14:00-15:00	B	(56)	冠、亞軍賽(53)W		冠、亞軍賽(54)W

